

SPARK
exhaust technology



RACING 2019

2015/2018

SBK 2018 VERSION

BMW S 1000 RR

GBM8811T

FULL TITANIUM SYSTEM
TITANIUM collector + KONIX silencer

3,56 kg
WEIGHT

GBM8808T

FULL SYSTEM
STAINLESS STEEL collector + KONIX silencer

In order to mount all BMW S 1000 RR full systems on previous model years (2009-2014) you need to add the optional bushing kit: SKIT019

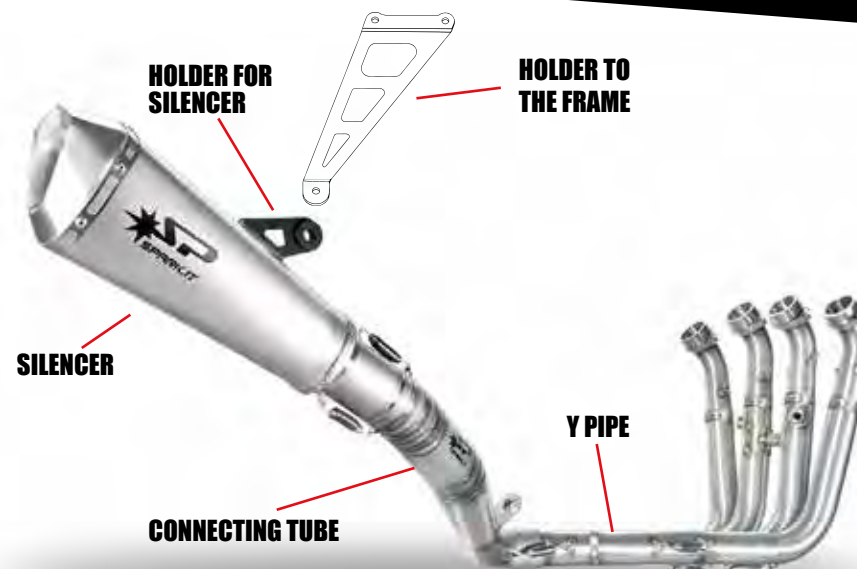

SPARE PARTS CODES:

	FOR GBM8811T Titanium System	FOR GBM8808T S.Steel System
TITANIUM SILENCER:	SGCM17300011T	SGCM17300005T
HOLDER FOR SILENCER:	SGATT425	SGATT425
HOLDER TO THE FRAME:	SGATT338	SGATT338
CONNECTING TUBE:	SGBM8801*10	SGBM8801*10
Y PIPE:	SGBM8809*02	SGBM8802*02

OPTIONAL dB KILLER: **G9954**

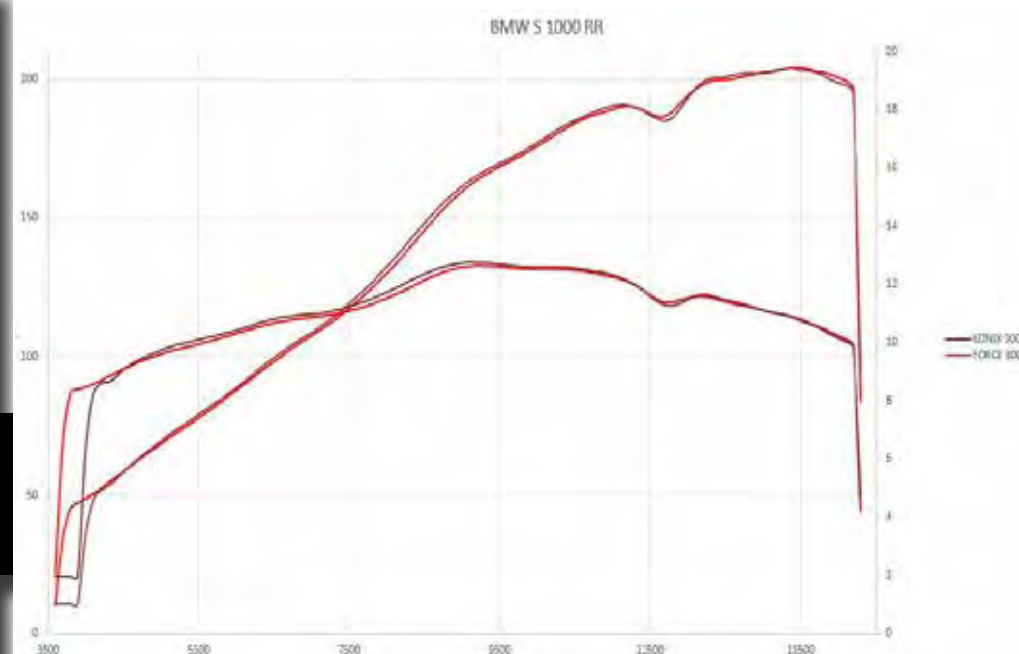

2015/2018

BMW S 1000 RR

GBM8801T FORCE 300mm (104dB)
GBM8803T FORCE 350mm (102dB)
 FULL TITANIUM SYSTEM
 TITANIUM collector + FORCE silencer

3,95 kg
4,07 kg
 WEIGHT

GBM8802T FORCE 300mm (104dB)
GBM8804T FORCE 350mm (102dB)
 FULL SYSTEM
 STAINLESS STEEL collector + FORCE silencer

In order to mount all BMW S 1000 RR full systems on previous model years (2009-2014) you need to add the optional bushing kit: SKIT019

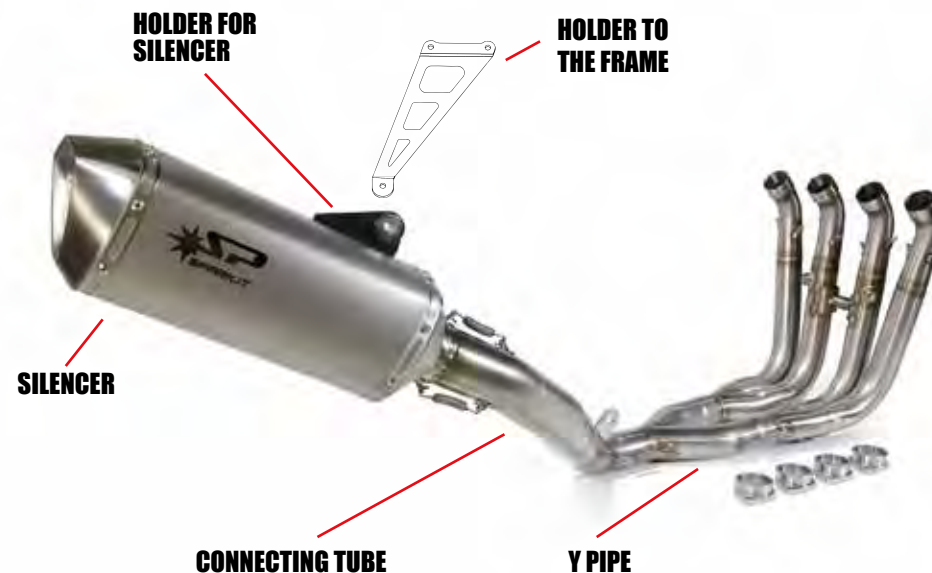

SPARE PARTS CODES:

GBM8801T Titanium System
GBM8803T

GBM8802T S.Steel System
GBM8804T

TITANIUM SILENCER 300mm:	SGCM12300013T	SGCM12300013T
TITANIUM SILENCER 350mm:	SGCM12350001T	SGCM12350001T
TITANIUM SILENCER L.400:	SGCM12400001T	SGCM12400001T
HOLDER FOR SILENCER:	SGATT337	SGATT337
HOLDER TO THE FRAME:	SGATT338	SGATT338
CONNECTING TUBE:	SGBM8801*01	SGBM8802*01
Y PIPE:	SGBM8803*01	SGBM8804*01

OPTIONAL dB KILLER: G9954

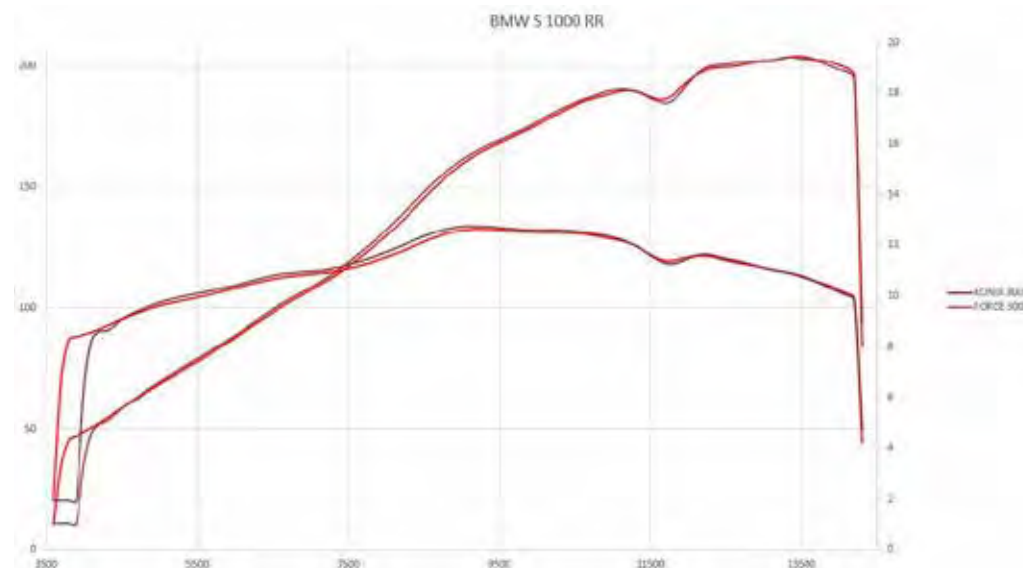

2015/2018

BMW S 1000 RR

GBM8805T

FULL TITANIUM SYSTEM
TITANIUM collector + MOTO GP silencer (113dB)

2,83 kg
WEIGHT

GBM8806T

FULL SYSTEM
STAINLESS STEEL collector + MOTO GP silencer (113dB)

In order to mount all BMW S 1000 RR full systems on previous model years (2009-2014) you need to add the optional bushing kit: SKIT019

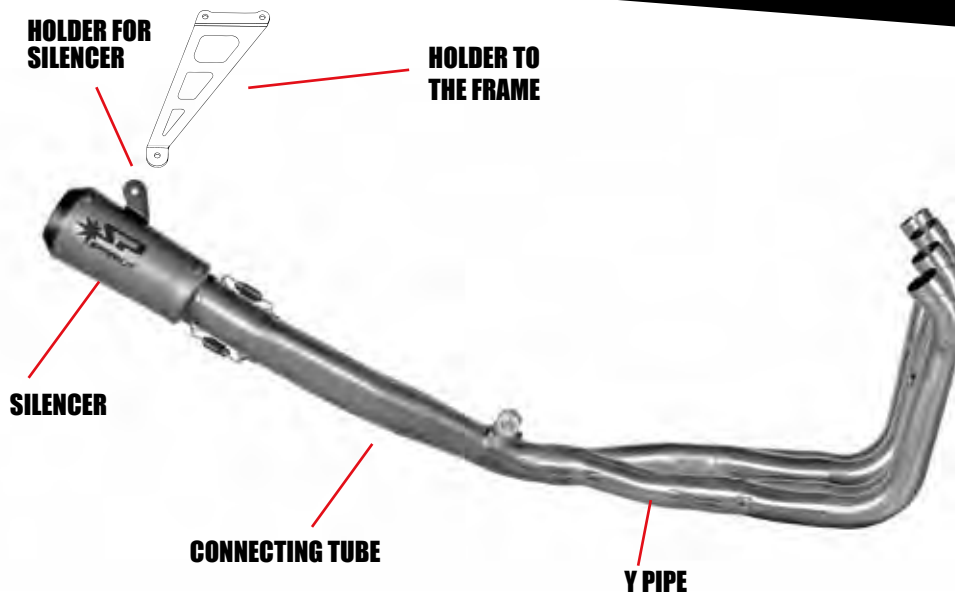

SPARE PARTS CODES:

	FOR GBM8805T Titanium System	FOR GBM8806T S.Steel System
TITANIUM SILENCER:	SGCM09175004T	SGCM09175004T
HOLDER FOR SILENCER:	SGATT277	SGATT277
HOLDER TO THE FRAME:	SGATT338	SGATT338
CONNECTING TUBE:	SGBM8803*01	SGBM8804*01
Y PIPE:	SGBM8801*02	SGBM8802*02

OPTIONAL dB KILLER: **G9969**





 **CAMPIONATO ITALIANO VELOCITÀ**

1st Place in National Trophy 1000



 **SPARK**
exhaust technology

vfo
Campeonato de España de Velocidad



**CARMELO MORALES
CAMPIONE SPAGNOLO
SUPERBIKE**

TT
ISLE OF MAN

2018/2019

DUCATI PANIGALE V4

GDU8820T

FULL TITANIUM SYSTEM
TITANIUM collector + GRID-0 silencer

2,7 kg
WEIGHT

GBM8819T

FULL SYSTEM
STAINLESS STEEL collector + GRID-0 silencer

3,5 kg
WEIGHT

SPARE PARTS CODES:

FOR **GBM8820T**
Titanium System

FOR **GBM8819T**
S.Steel System

TITANIUM SILENCER:

HOLDER FOR SILENCER:

HOLDER TO THE FRAME:

CONNECTING TUBE:

Y PIPE:



2018/2019

DUCATI PANIGALE V4

GBM8821T

FULL SYSTEM
STAINLESS STEEL collector + FORCE silencer

4,9 kg
WEIGHT

102 dB LEVEL

SPARE PARTS CODES:

FOR **GBM8821T**
S.Steel System

TITANIUM SILENCER:

HOLDER FOR SILENCER:

HOLDER TO THE FRAME:

CONNECTING TUBE:

Y PIPE:

OPTIONAL dB KILLER:

69954



2018/2019

DUCATI PANIGALE V4

GBM8822T

FULL SYSTEM

STAINLESS STEEL collector + KONIX silencer

4,2 kg

WEIGHT

SPARE PARTS CODES:

TITANIUM SILENCER:

HOLDER FOR SILENCER:

HOLDER TO THE FRAME:

CONNECTING TUBE:

Y PIPE:

FOR **GBM8822T**
S.Steel System

OPTIONAL dB KILLER:

69954



GDU8823T

3/4 SYSTEM

S.STEEL link pipe + GRID-O Silencer +
FORCE Silencer (102dB)



GDU8824T

3/4 SYSTEM

TITANIUM link pipe + GRID-O Silencer +
FORCE Silencer (102dB)



2015/2018

HONDA MOTO2 KALEX

GH08808T

FULL TITANIUM SYSTEM - 2016
TITANIUM collector + MOTO GP silencer



GH08808T

N°	CODICE	DESCRIZIONE
1	SGHO8805*04	COLLETTORE CILINDRO 1
2	SGHD8805*05	COLLETTORE CILINDRO 2
3	SGHO8805*06	COLLETTORE CILINDRO 3
4	SGHO8805*07	COLLETTORE CILINDRO 4
5	SGHD8814*03	BIVIO DX - COLLETTORE CILINDRO 1/2
6	SGHO8814*02	BIVIO SX - COLLETTORE CILINDRO 3/4
7	SGHO8814*01	RACCORDO CON SILENZIATORE SALDATO

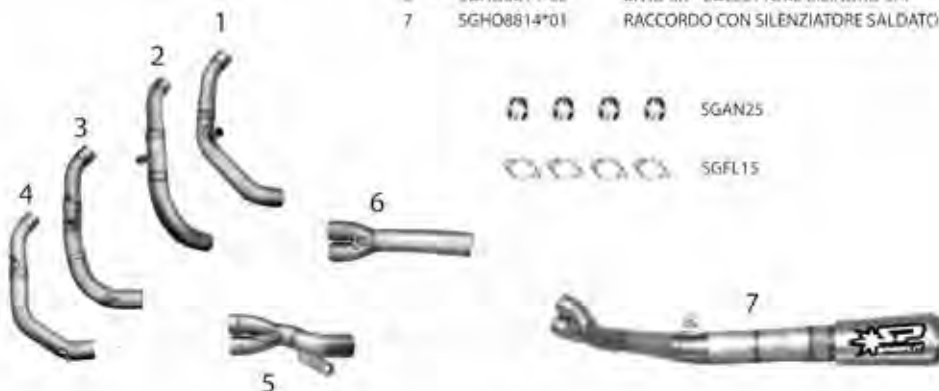

● ● ● ● SGAN25

○ ○ ○ ○ SGFL15



#1st PLACE MOTO2
#MUGELLO
#MATTIA PASINI
#SPARK EXHAUST



Moto2™



ERIC GRANADO (TEAM PROMORACING) CAMPIONE EUROPEO MOTO2

2017/2018

HONDA CBR 1000 RR

GH08821T

FULL TITANIUM SYSTEM
TITANIUM collector + FORCE silencer

4,6 kg (-2,6)

WEIGHT

GH08822T

FULL SYSTEM
STAINLESS STEEL collector + FORCE silencer

6,5 kg (-0,7)

WEIGHT

102 dB LEVEL

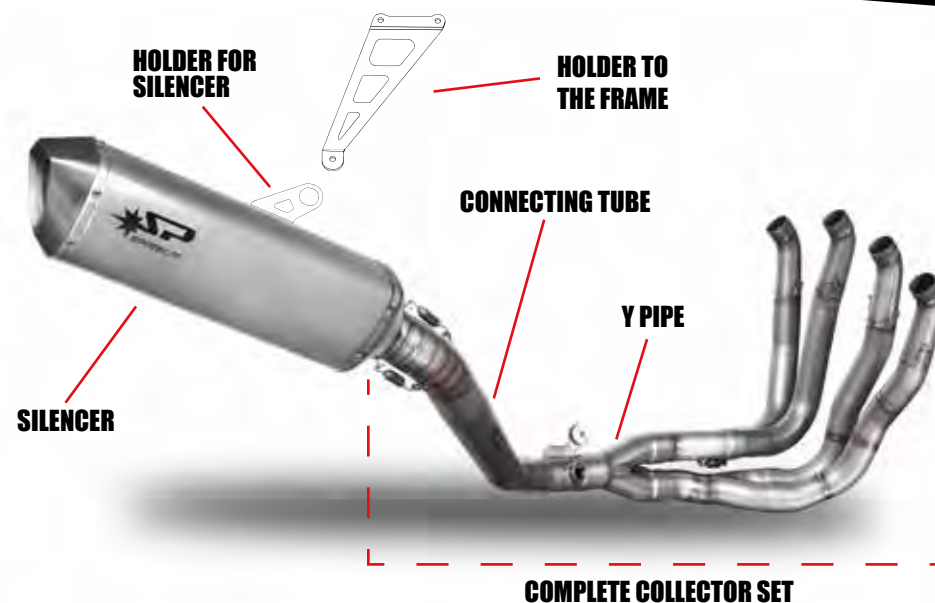

SPARE PARTS CODES:

FOR **GH08821T**
Titanium System

FOR **GH08822T**
S.Steel System

TITANIUM SILENCER: SGCM12350001T SGCM12350001T

TITANIUM SILENCER L.400 SGCM12400001T SGCM12400001T

HOLDER FOR SILENCER: SGATT252 SGATT252

HOLDER TO THE FRAME: SGATT541 SGATT541

CONNECTING TUBE: SGH08819*01 SGH08820*01

Y PIPE: SGH08819*02 SGH08820*02

COMPLETE COLLECTOR SET: **GH08819** **GH08820**

OPTIONAL dB KILLER: G9954

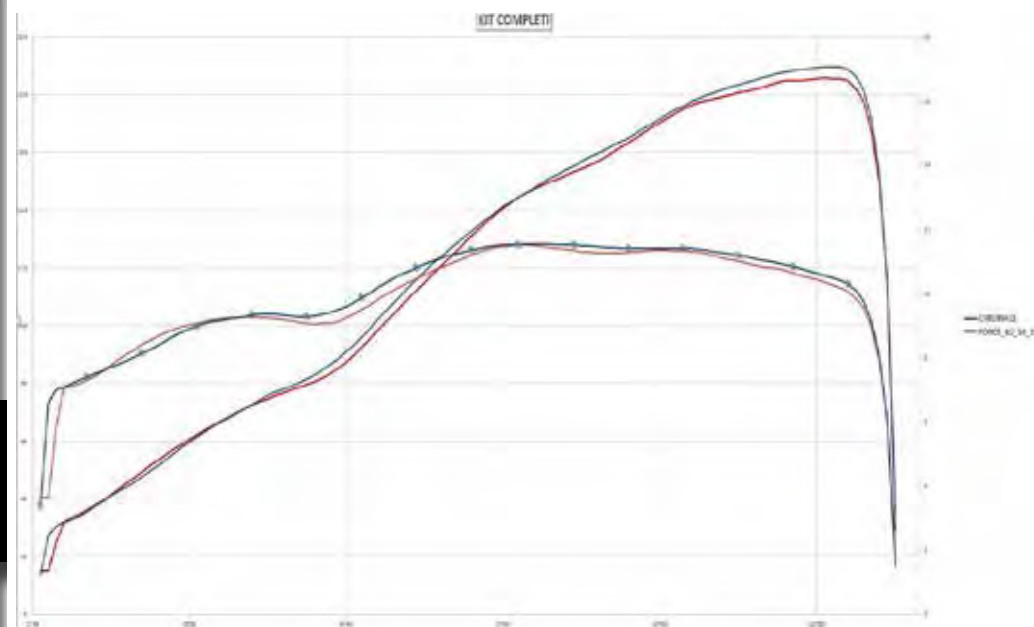

2017/2018

HONDA CBR 1000 RR

GH08824T

FULL SYSTEM
TITANIUM collector + KONIX silencer

4,0 kg (-3,2)
WEIGHT

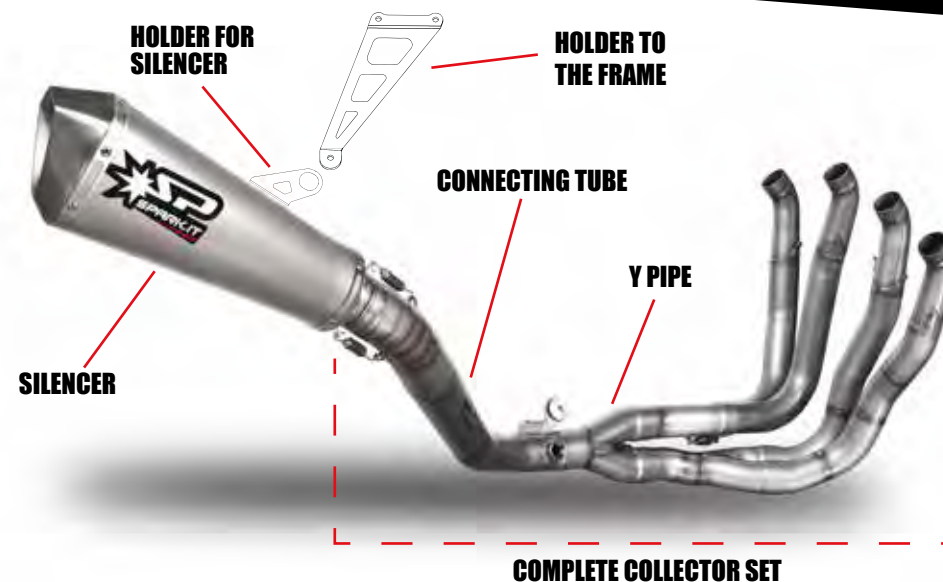

SPARE PARTS CODES:

FOR **GH08824T**
Titanium System

TITANIUM SILENCER:	SGCM17300008T
HOLDER FOR SILENCER:	SGATT568
HOLDER TO THE FRAME:	SGATT541
CONNECTING TUBE:	SGH08819*01
Y PIPE:	SGH08819*02

COMPLETE COLLECTOR SET:

GH08819

OPTIONAL dB KILLER:

G9954

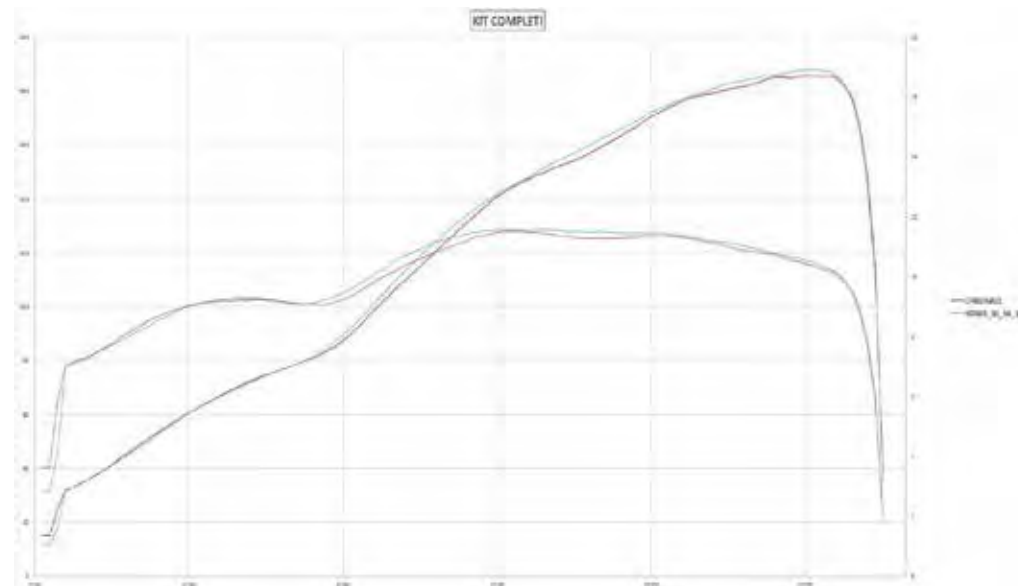

2017/2018

HONDA CBR 1000 RR

GH08819T

FULL TITANIUM SYSTEM
TITANIUM collector + FORCE silencer

4,4 kg (-2,7)

WEIGHT

GH08820T

FULL SYSTEM
STAINLESS STEEL collector + FORCE silencer

6,3 kg (-0,9)

WEIGHT

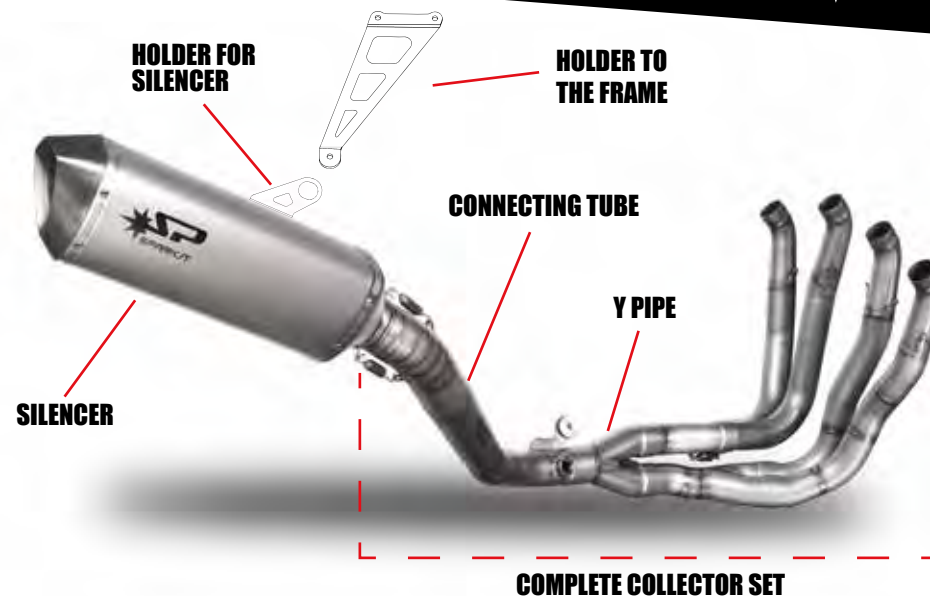

SPARE PARTS CODES:

	FOR GH08819T Titanium System	FOR GH08820T S.Steel System
TITANIUM SILENCER:	SGCM12300015T	SGCM12300015T
HOLDER FOR SILENCER:	SGATT252	SGATT252
HOLDER TO THE FRAME:	SGATT541	SGATT541
CONNECTING TUBE:	SGH08819*01	SGH08820*01
Y PIPE:	SGH08819*02	SGH08820*02

COMPLETE COLLECTOR SET:

GH08819

GH08820

OPTIONAL dB KILLER:

G9954

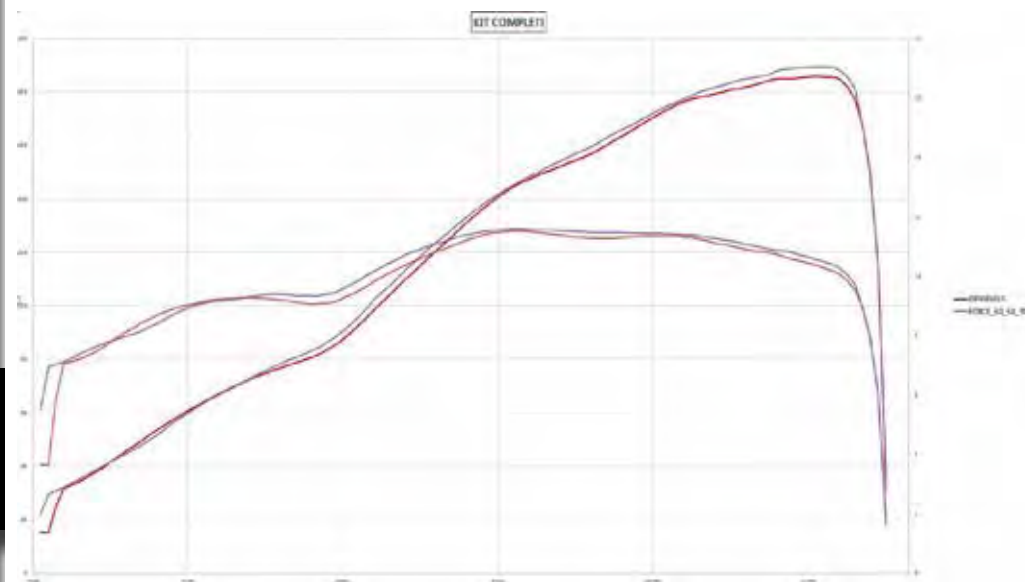

2017/2018

HONDA CBR 1000 RR

GH08823T

FULL TITANIUM SYSTEM
TITANIUM collector + MOTO GP silencer

3,3 kg (-3,9)
WEIGHT

SPARE PARTS CODES:

FOR **GH08823T**
Titanium System

TITANIUM SILENCER:	SGCM09175031T
HOLDER FOR SILENCER:	SGATT585
HOLDER TO THE FRAME:	SGATT541
CONNECTING TUBE:	SGH08819*01
Y PIPE:	SGH08819*02

COMPLETE COLLECTOR SET: **GH08819**

OPTIONAL dB KILLER: 69969

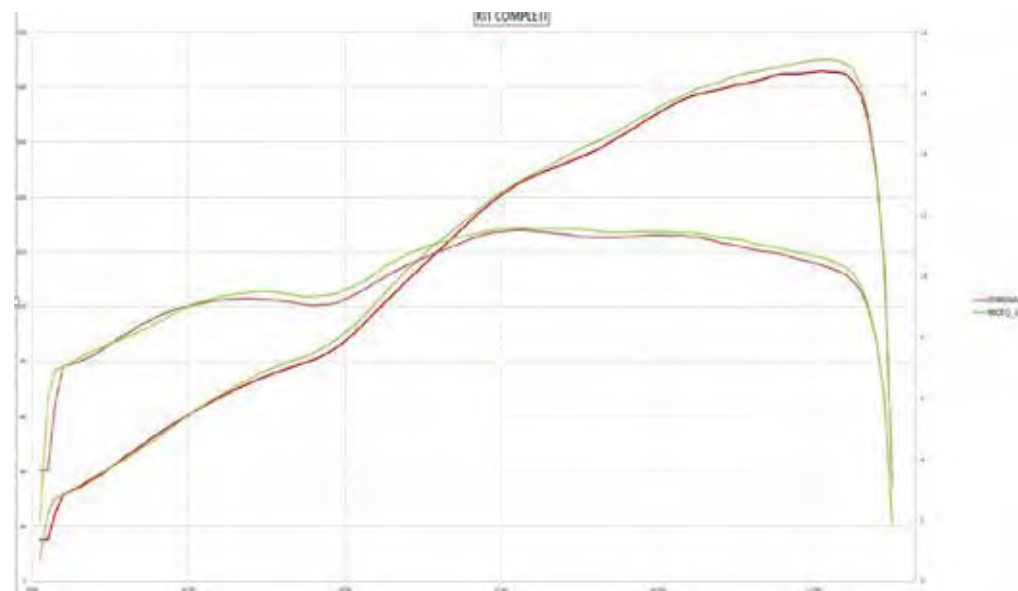
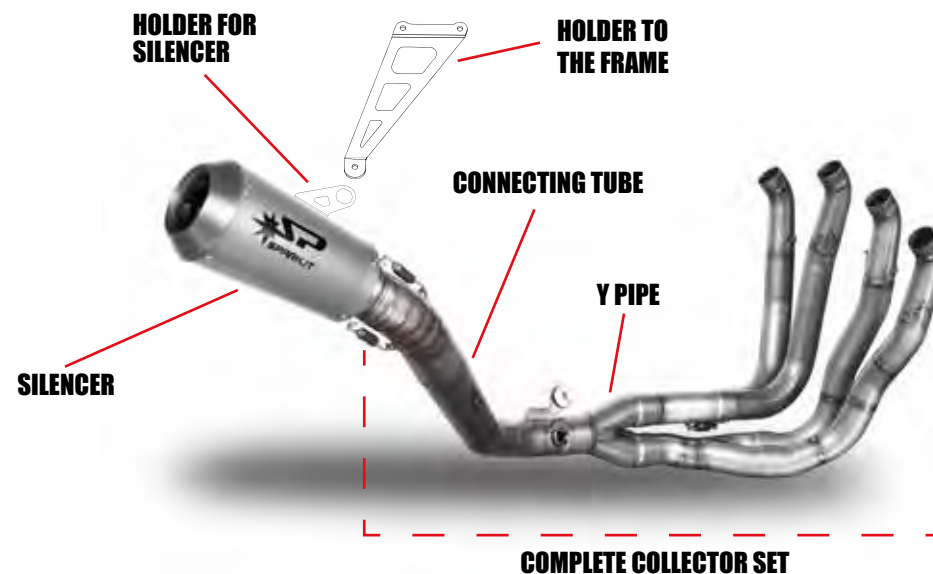





2018

KAWASAKI NINJA 400

GKA8825T

FULL SYSTEM

STAINLESS STEEL collector + FORCE silencer

102 dB LEVEL



SPARE PARTS CODES:

FOR **GKA8825T**
S.Steel System

TITANIUM SILENCER:

SGCM12300015T

HOLDER FOR SILENCER:

SGATT614

HOLDER TO THE FRAME:

SGATT611

CONNECTING TUBE:

SGKA8823*01

Y PIPE:

SGKA8823*02

OPTIONAL dB KILLER:

G9944

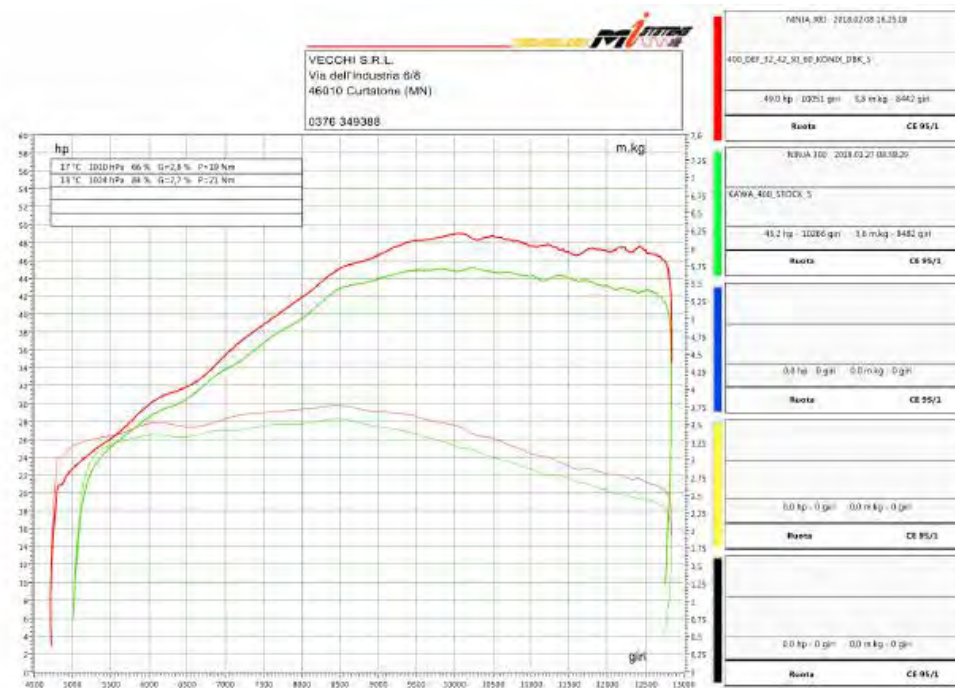

2018

KAWASAKI NINJA 400

GKA8824T

FULL TITANIUM SYSTEM
TITANIUM collector + KONIX silencer

GKA8823T

FULL SYSTEM
STAINLESS STEEL collector + KONIX silencer



SPARE PARTS CODES:

	FOR GKA8824T Titanium System	FOR GKA8823T S.Steel System
TITANIUM SILENCER:	SGCM17300008T	SGCM17300008T
HOLDER FOR SILENCER:	SGATT613	SGATT613
HOLDER TO THE FRAME:	SGATT611	SGATT611
CONNECTING TUBE:	SGKA8824*01	SGKA8823*01
Y PIPE:	SGKA8824*02	SGKA8823*02

OPTIONAL dB KILLER:

G9944

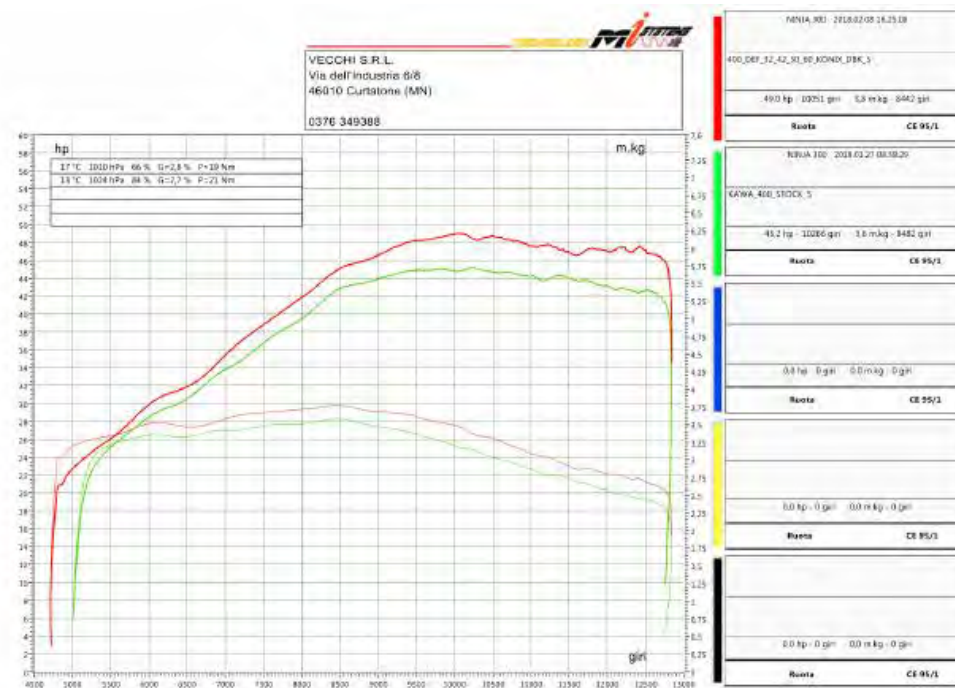

2018

KAWASAKI NINJA 400

GKA8826T

FULL SYSTEM

STAINLESS STEEL collector + TITANIUM MOTO GP silencer

GKA8826C

FULL SYSTEM

STAINLESS STEEL collector + CARBON MOTO GP silencer



SPARE PARTS CODES:

	FOR GKA8826T S.Steel System	FOR GKA8826C S.Steel System
TITANIUM SILENCER:	SGCM09175016T	
CARBON SILENCER:		
HOLDER FOR SILENCER:	SGATT615	
HOLDER TO THE FRAME:	SGATT611	SGATT611
CONNECTING TUBE:	SGKA8823*01	SGKA8823*01
Y PIPE:	SGKA8823*02	SGKA8823*02

OPTIONAL dB KILLER: G9969

2009/2018

KAWASAKI ZX-6R

GKA8806T

FULL SYSTEM
STAINLESS STEEL collector + FORCE silencer

GKA8807T

FULL TITANIUM SYSTEM
TITANIUM collector + FORCE silencer

102 dB LEVEL

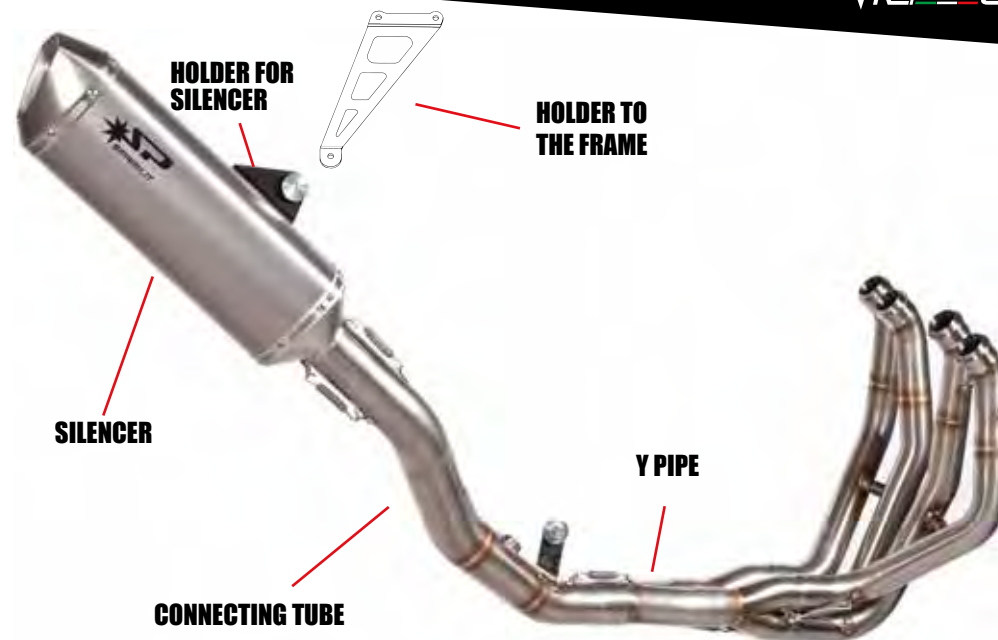

SPARE PARTS CODES:

	FOR GKA8807T Titanium System	FOR GKA8806T S.Steel System
TITANIUM SILENCER:	SGCM12350001T	SGCM12350001T
TITANIUM SILENCER L.400	SGCM12400001T	SGCM12400001T
HOLDER FOR SILENCER:	SGATT252	SGATT252
HOLDER TO THE FRAME:	SGATT236	SGATT236
CONNECTING TUBE:	SGKA8807*01	SGKA8806*01
Y PIPE:	SGKA8807*02	SGKA8806*02

OPTIONAL dB KILLER: **G9954**

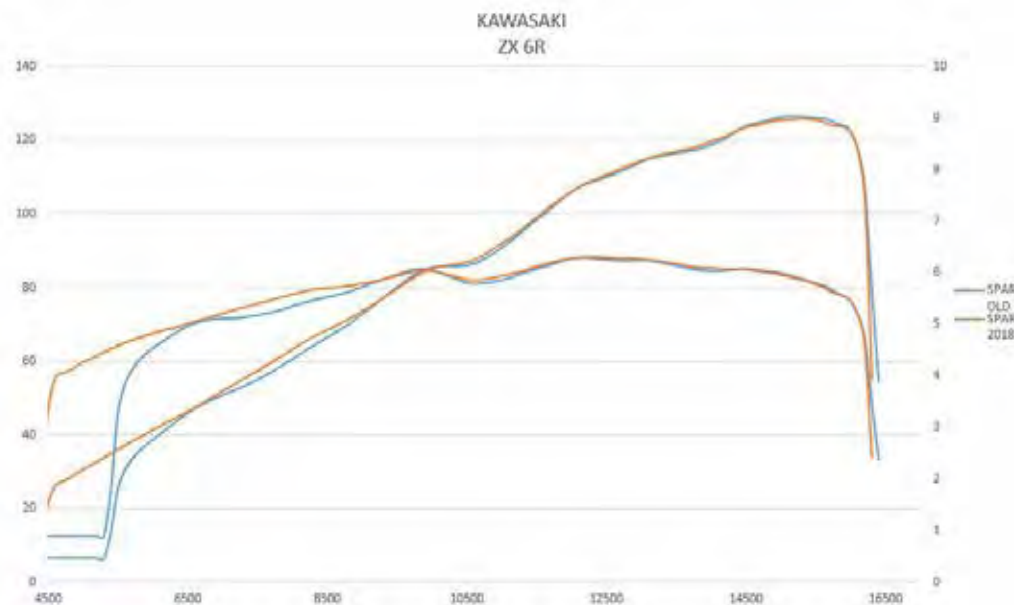

2009/2018

KAWASAKI ZX-6R

GKA8821T

FULL TITANIUM SYSTEM
TITANIUM collector + KONIX silencer

GKA8822T

FULL TITANIUM SYSTEM
STAINLESS STEEL collector + KONIX silencer



SPARE PARTS CODES:

	FOR GKA8821T Titanium System	FOR GKA8822T S.Steel System
TITANIUM SILENCER:	SGCM17300008T	SGCM17300008T
HOLDER FOR SILENCER:	SGATT446	SGATT446
HOLDER TO THE FRAME:	SGATT236	SGATT236
CONNECTING TUBE:	SGKA8807*01	SGKA8806*01
Y PIPE:	SGKA8807*02	SGKA8806*02

OPTIONAL dB KILLER: **G9954**

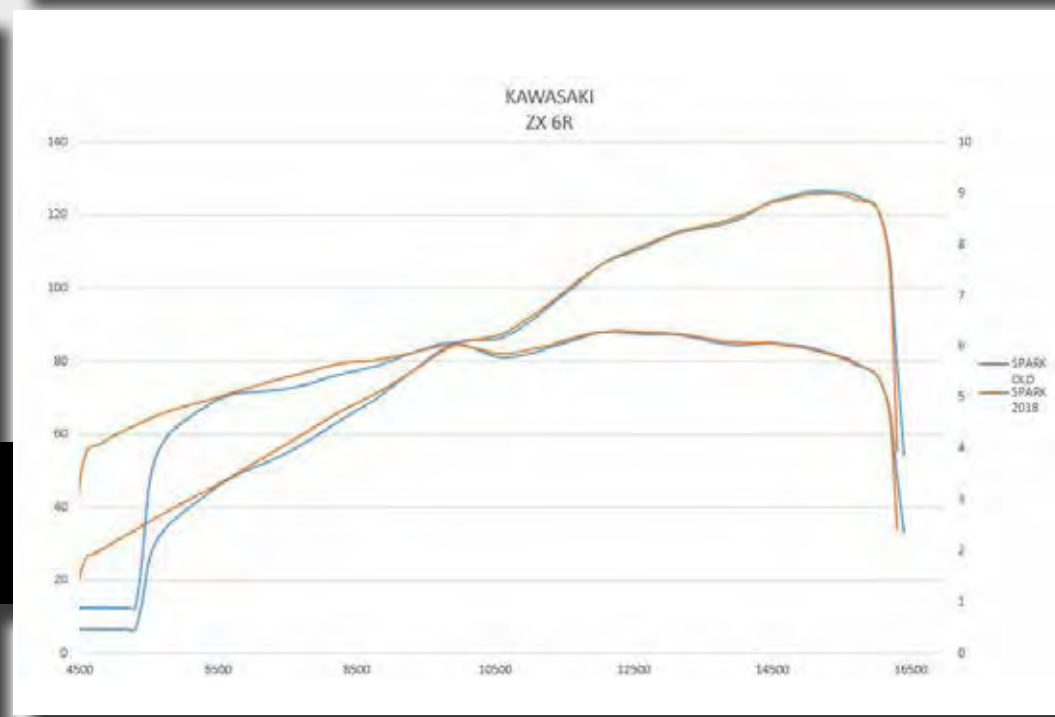



ORELAC acing

SUPERSPORT™
FIM WORLD CHAMPIONSHIP



2011/2018

KAWASAKI ZX-10R

GKA8817T

3/4 SYSTEM

TITANIUM collector + FORCE silencer (L.300) 107dB

2,5 kg (-4,5)

WEIGHT

GKA8818T

3/4 SYSTEM

TITANIUM collector + FORCE silencer (L.350) 102dB

2,9 kg (-4,1)

WEIGHT



SPARE PARTS CODES:

FOR **GKA8817T**
Titanium System

FOR **GKA8818T**
Titanium System

TITANIUM SILENCER:

TITANIUM SILENCER L.400

HOLDER FOR SILENCER:

HOLDER TO THE FRAME:

CONNECTING TUBE:

OPTIONAL dB KILLER:

G9954

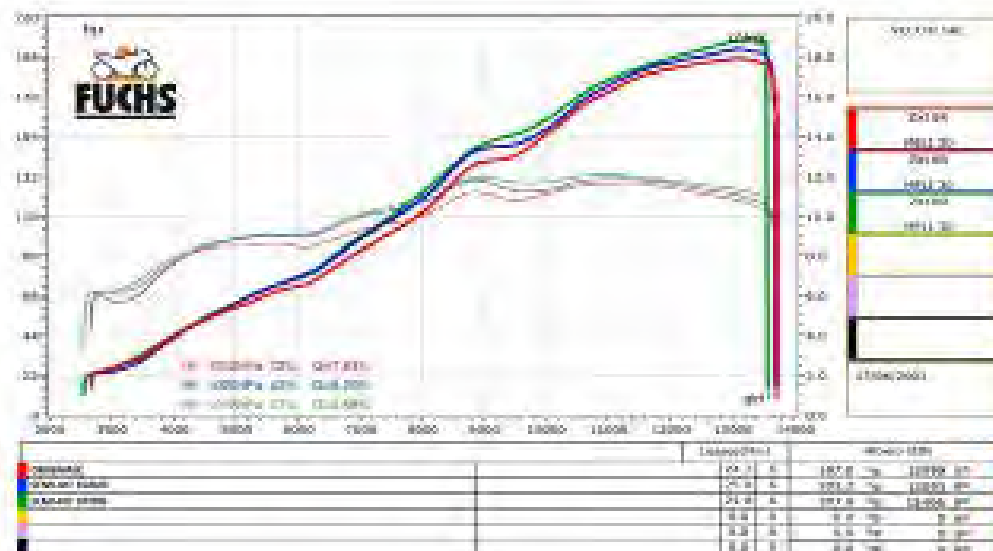

2011/2018

KAWASAKI ZX-10R

GKA8819T

3/4 SYSTEM

TITANIUM collector + FORCE silencer (L.300) 107dB

1,9 kg (-5,1)

WEIGHT



SPARE PARTS CODES:

FOR **GKA8819T**
Titanium System

TITANIUM SILENCER:

TITANIUM SILENCER L.400

HOLDER FOR SILENCER:

HOLDER TO THE FRAME:

CONNECTING TUBE:

OPTIONAL dB KILLER:

G9954

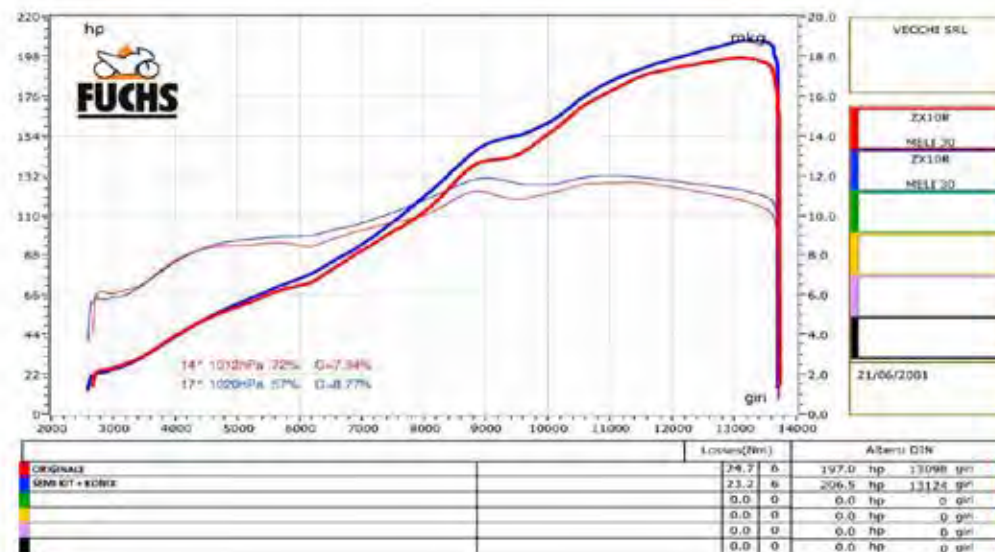

2011/2018

KAWASAKI ZX-10R

GKA8816T

3/4 SYSTEM

TITANIUM collector + FORCE silencer (L.300) 107dB

1,5 kg (-5,5)

WEIGHT



SPARE PARTS CODES:

FOR **GKA8816T**
Titanium System

TITANIUM SILENCER:

TITANIUM SILENCER L.400

HOLDER FOR SILENCER:

HOLDER TO THE FRAME:

CONNECTING TUBE:

OPTIONAL dB KILLER:

G9969

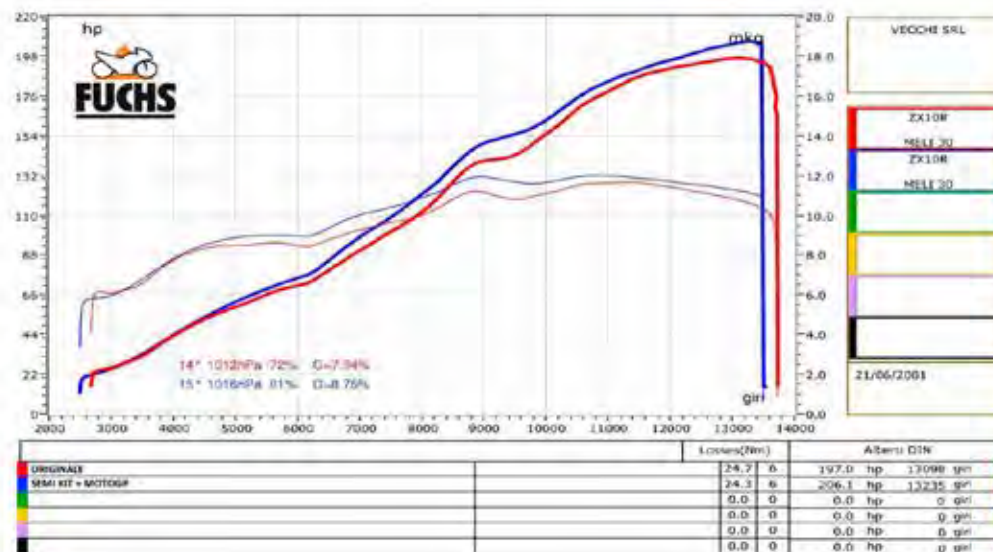

2011/2018

KAWASAKI ZX-10R

GKA8802T

FULL TITANIUM SYSTEM Stock Version
TITANIUM collector + FORCE silencer

4,9 kg (-4,4)
WEIGHT

GKA8803T

FULL SYSTEM Stock Version
STAINLESS STEEL collector + FORCE silencer

102 dB LEVEL

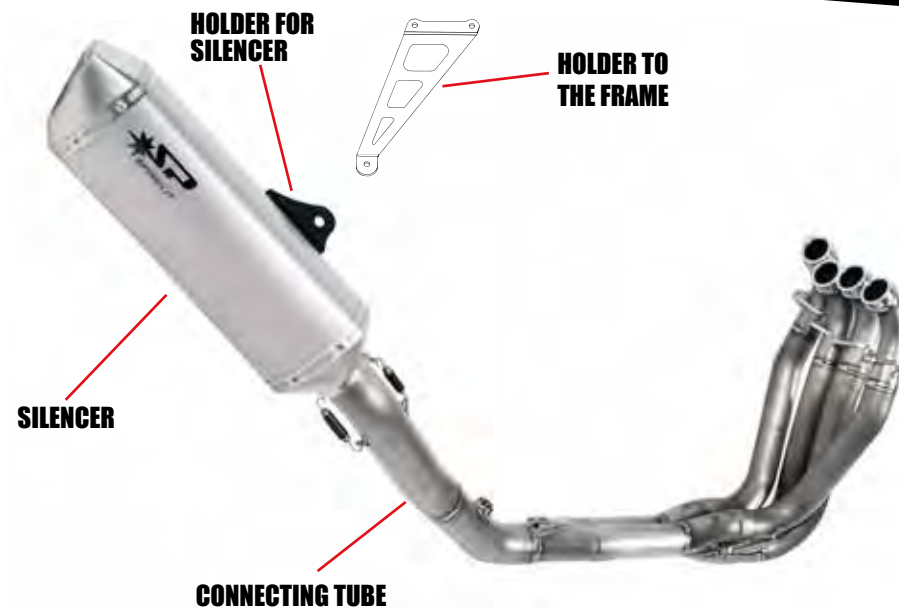

SPARE PARTS CODES:

FOR **GKA8802T**
Titanium System

FOR **GKA8803T**
S.Steel System

TITANIUM SILENCER:	SGCM12350001T	SGCM12350001T
TITANIUM SILENCER L.400	SGCM12400001T	SGCM12400001T
HOLDER FOR SILENCER:	SGATT253	SGATT253
HOLDER TO THE FRAME:	SGATT172	SGATT172
CONNECTING TUBE:	SGKA8802*01	SGKA8803*01

OPTIONAL dB KILLER:

G9954

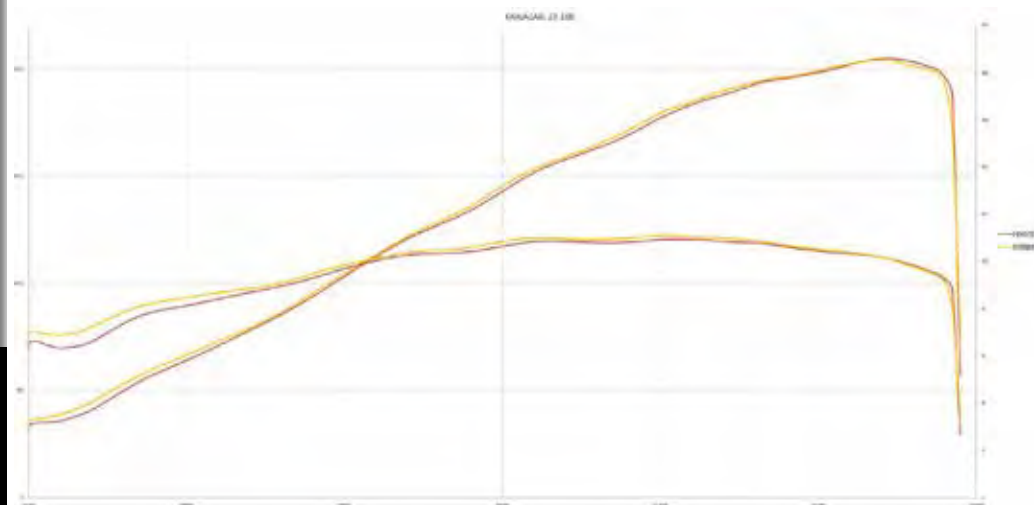

2011/2018

KAWASAKI ZX-10R

GKA8814T

FULL TITANIUM SYSTEM
TITANIUM collector + FORCE silencer

4,9 kg (-4,4)
WEIGHT

SPARE PARTS CODES:

FOR **GKA8814T**
Titanium System

TITANIUM SILENCER: SGCM12350013T

HOLDER FOR SILENCER: SGATT253

HOLDER TO THE FRAME: SGATT418

CONNECTING TUBE: SGKA8814*01

dB KILLER INCLUDED:

G9954

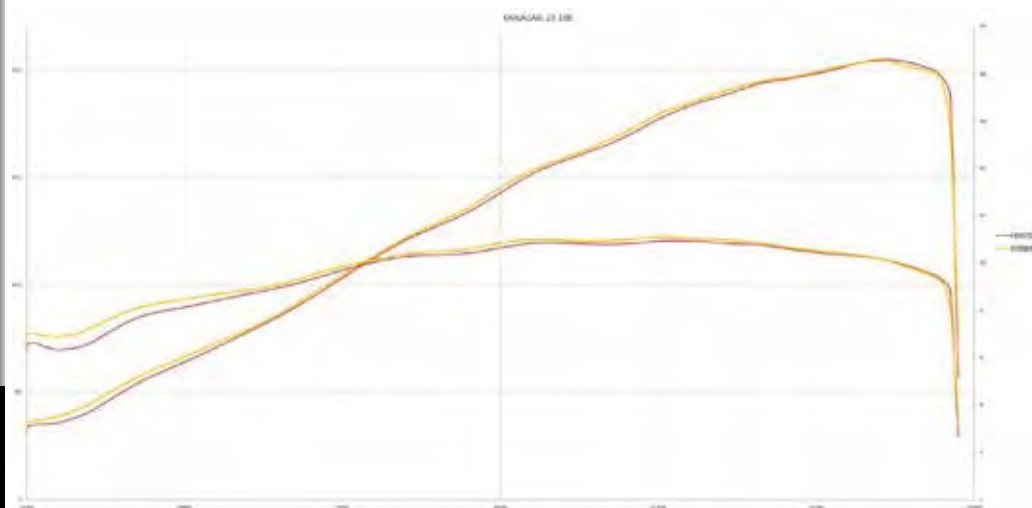
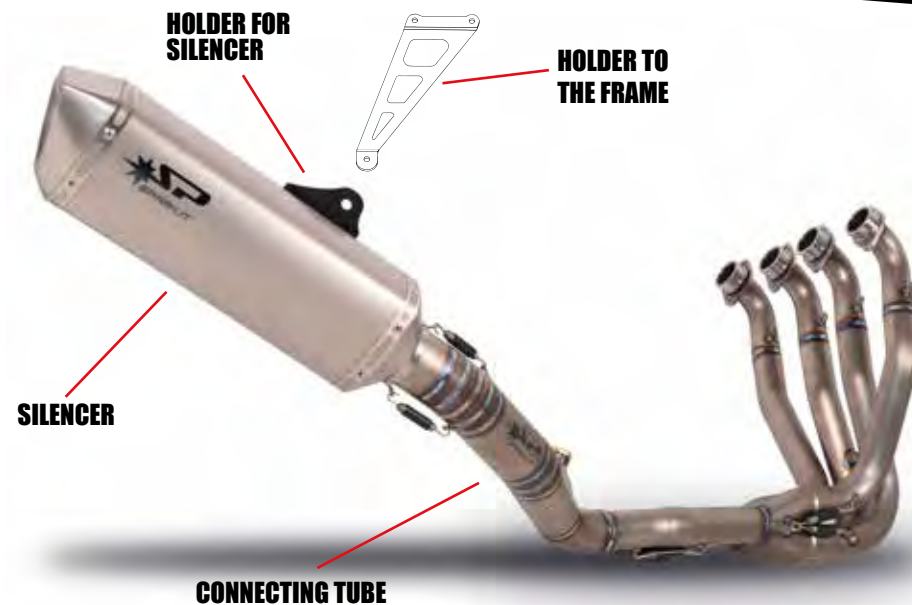

2011/2018

KAWASAKI ZX-10R

GKA8815T

FULL TITANIUM SYSTEM SBK
TITANIUM collector + KONIX silencer

4,4 kg (-4,9)

WEIGHT



SPARE PARTS CODES:

FOR **GKA8815T**
Titanium System

TITANIUM SILENCER:

SGCM17300005T

HOLDER FOR SILENCER:

SGATT446

HOLDER TO THE FRAME:

SGATT418

CONNECTING TUBE:

SGKA8814*01

dB KILLER INCLUDED:

G9954

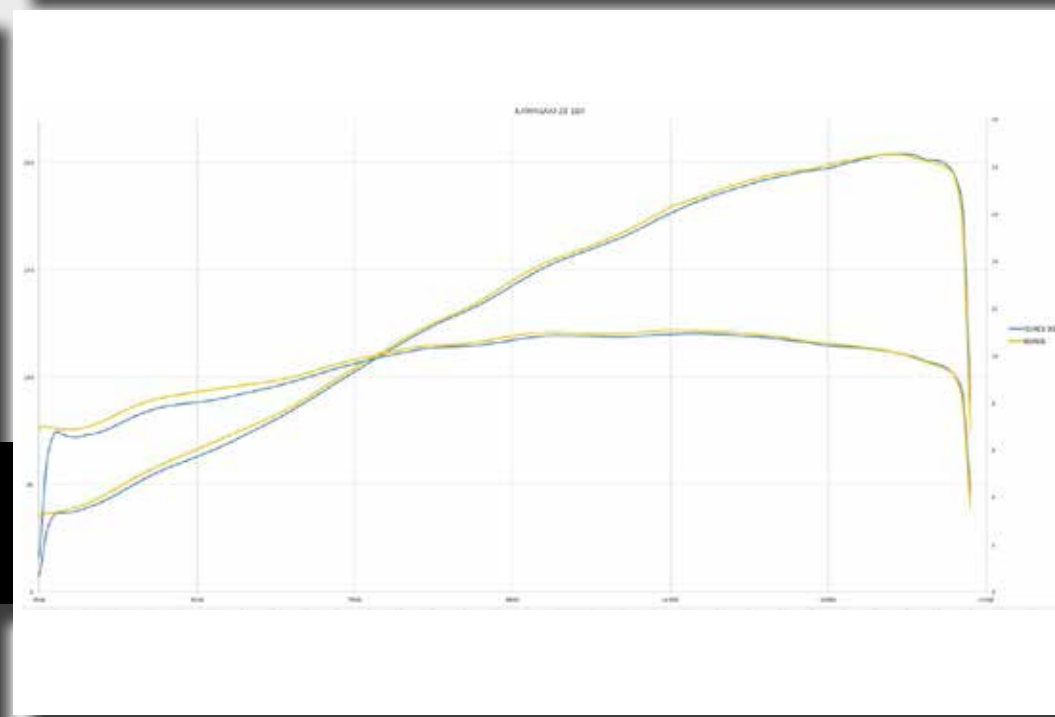

2011/2017

KAWASAKI ZX-10R

GKA8820T
GKA8820C

FULL TITANIUM SYSTEM SBK
TITANIUM collector + MOTO GP silencer

3,6 kg (-5,7)
WEIGHT



SPARE PARTS CODES:

GKA8820T Titanium
GKA8820C System

TITANIUM SILENCER:	SGCM09175027T
HOLDER FOR TITANIUM SILENCER:	SGATT539
CARBON SILENCER:	SGCM26175002C
HOLDER FOR CARBON SILENCER:	SGATT538
HOLDER TO THE FRAME:	SGATT418
CONNECTING TUBE:	SGKA8814*01

dB KILLER INCLUDED: **G9969**



2011/2018

KAWASAKI ZX-10R

GKA8828T

FULL TITANIUM SYSTEM SBK
TITANIUM collector + KONIX silencer



SPARE PARTS CODES:

FOR **GKA8828T**
Titanium System

TITANIUM SILENCER:

HOLDER FOR SILENCER:

HOLDER TO THE FRAME:

CONNECTING TUBE:

dB KILLER INCLUDED:

G9954



ORELAC acing

SBK **MOTUL**
FIM SUPERBIKE WORLD CHAMPIONSHIP



2017/2018

SUZUKI GSX-R 1000

GSU8808T

FULL SYSTEM
STAINLESS STEEL collector + KONIX silencer

5,6 kg (-3,4)
WEIGHT

GSU8809T

FULL TITANIUM SYSTEM
TITANIUM collector + KONIX silencer

4,4 kg (-2,7)
WEIGHT

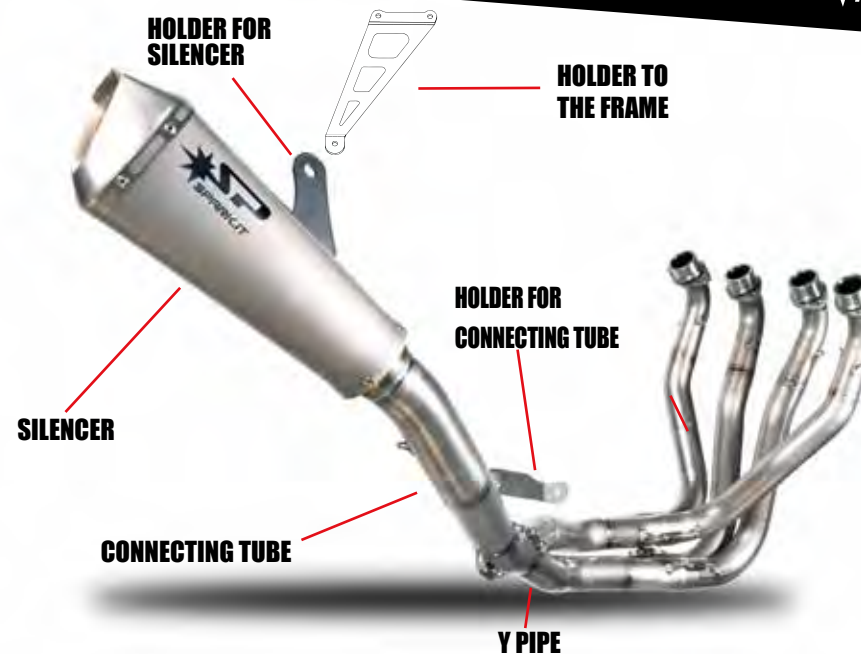

SPARE PARTS CODES:

	FOR GSU8809T Titanium System	FOR GSU8808T S.Steel System
TITANIUM SILENCER:	SGCM17300013T	SGCM17300013T
HOLDER FOR SILENCER:	SGATT565	SGATT565
HOLDER TO THE FRAME:	SGATT564	SGATT564
CONNECTING TUBE:	SGSU8804*01	SGSU8805*01
HOLDER FOR CONNECTING TUBE:	SGATT567	SGATT567
Y PIPE:	SGSU8804*02	SGSU8805*02

dB KILLER INCLUDED:

G9954

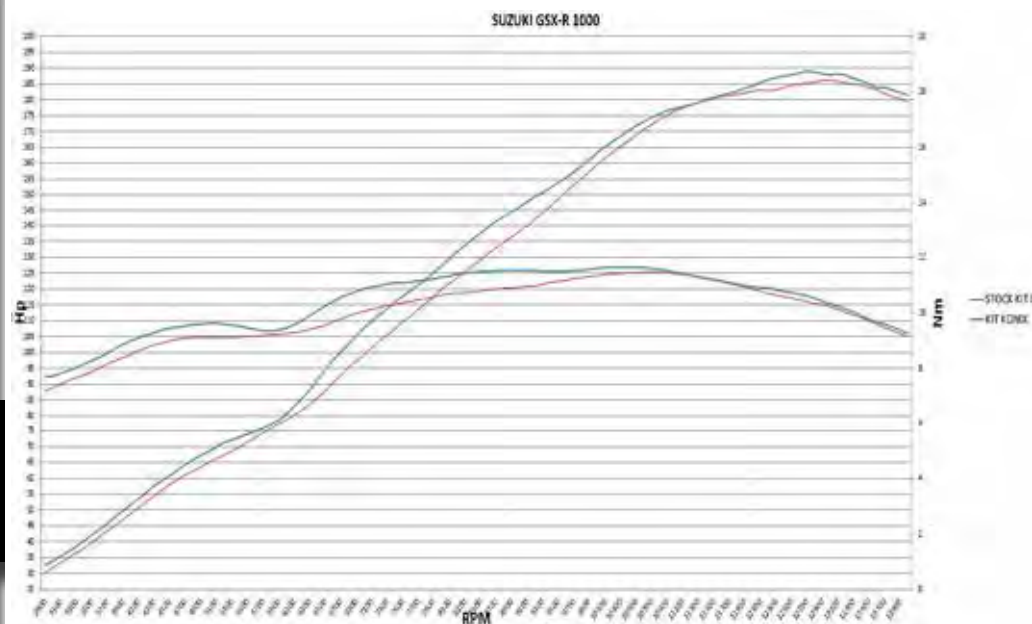

2017/2018

SUZUKI GSX-R 1000

GSU8804T

FULL SYSTEM
STAINLESS STEEL collector + FORCE silencer

6 kg (-3)
WEIGHT

GSU8805T

FULL TITANIUM SYSTEM
TITANIUM collector + FORCE silencer

4,9 kg (-4,17)
WEIGHT



SPARE PARTS CODES:

	FOR GSU8805T Titanium System	FOR GSU8804T S.Steel System
TITANIUM SILENCER:	SGCM12300017T	SGCM12300017T
HOLDER FOR SILENCER:	SGATT269	SGATT269
HOLDER TO THE FRAME:	SGATT564	SGATT564
CONNECTING TUBE:	SGSU8804*01	SGSU8805*01
HOLDER FOR CONNECTING TUBE:	SGATT567	SGATT567
Y PIPE:	SGSU8804*02	SGSU8805*02

dB KILLER INCLUDED: 69954

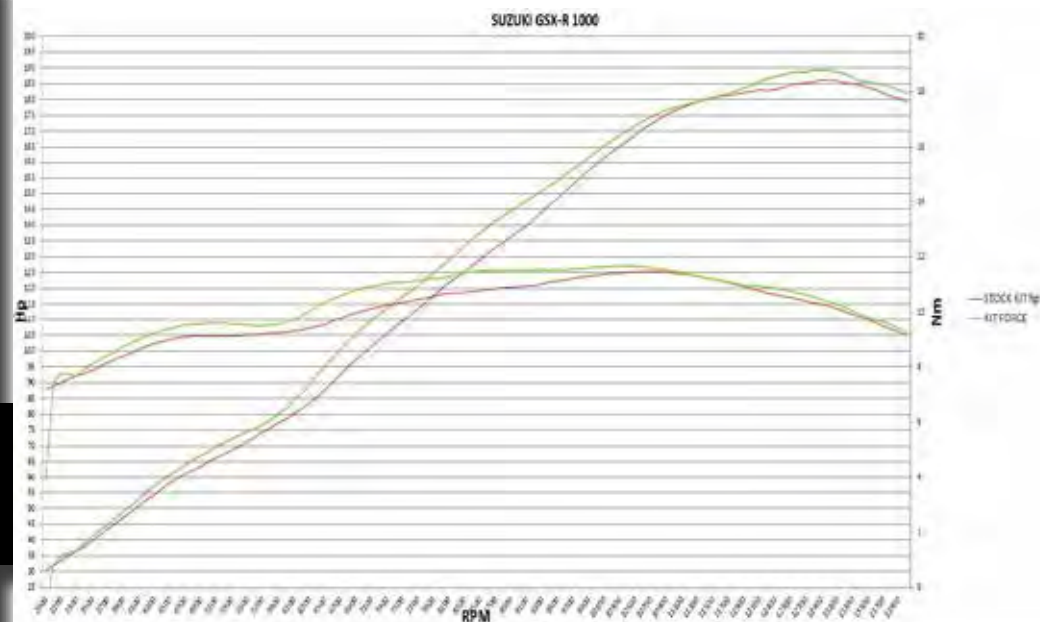

2017/2018

SUZUKI GSX-R 1000

GSU8806T

FULL SYSTEM
STAINLESS STEEL collector + MOTO GP silencer

4,9 kg (-4,1)
WEIGHT

GSU8807T

FULL TITANIUM SYSTEM
TITANIUM collector + MOTO GP silencer

3,8 kg (-5,2)
WEIGHT



SPARE PARTS CODES:

FOR **GSU8807T**
Titanium System

FOR **GSU8806T**
S.Steel System

TITANIUM SILENCER:	SGCM09175032T	SGCM09175032T
HOLDER FOR SILENCER:	SGATT586	SGATT586
HOLDER TO THE FRAME:	SGATT564	SGATT564
CONNECTING TUBE:	SGSU8804*01	SGSU8805*01
HOLDER FOR CONNECTING TUBE:	SGATT567	SGATT567
Y PIPE:	SGSU8804*02	SGSU8805*02

dB KILLER INCLUDED: **G9963**

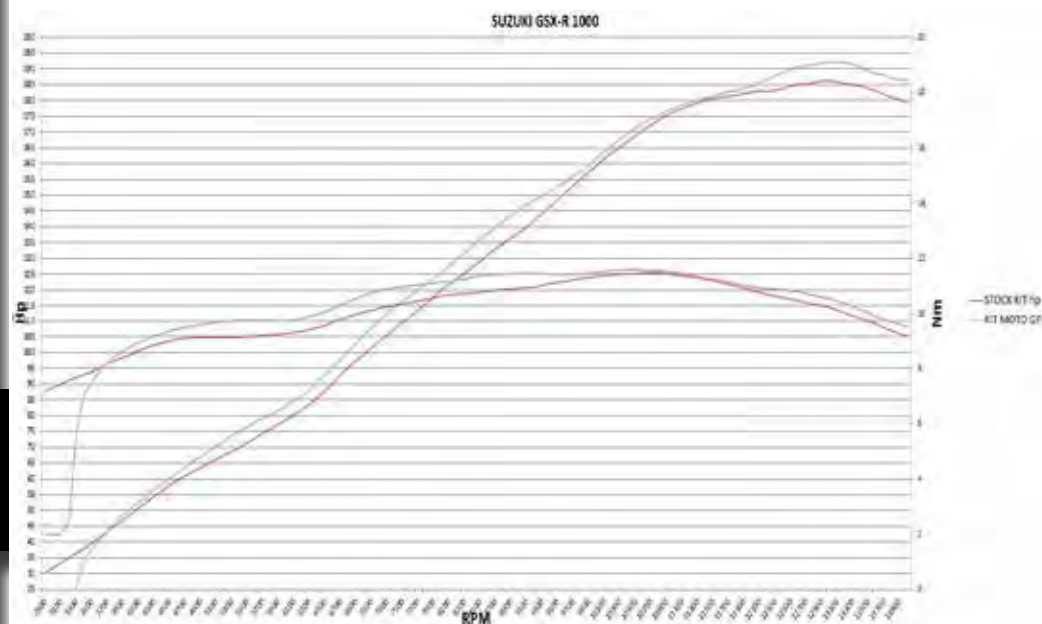

2019

TRIUMPH MOTO2

COMING SOON 2019



2017/2018

YAMAHA YZ-F R3

GYA8857T

FULL SYSTEM SS300 version
STAINLESS STEEL collector + FORCE
L.300 silencer

4,2 kg (-4)
WEIGHT



**Campione italiano
SSP300**

Luca Bernardi

SPARE PARTS CODES:

FOR **GYA8857T**
S.Steel System

TITANIUM SILENCER: **SGCM12300004T**

HOLDER FOR SILENCER: **SGATT520**

HOLDER TO THE FRAME: **SGATT518**

CONNECTING TUBE: **SGYA8856*01**

Y PIPE: **SGYA8834*02**

dB KILLER INCLUDED:

G9944

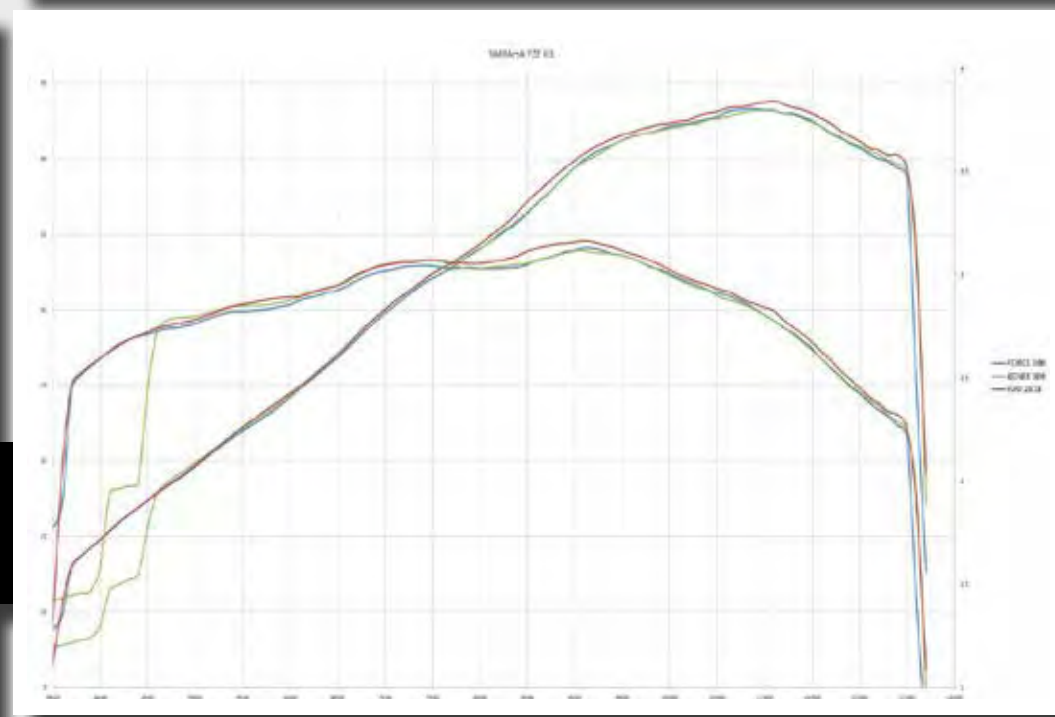

2017/2018

YAMAHA YZ-F R3

GYA8837T

FULL SYSTEM SS300 version
STAINLESS STEEL collector + FORCE
L.300 silencer

4,2 kg (-4)
WEIGHT

102 dB LEVEL

SPARE PARTS CODES:

FOR **GYA8837T**
S.Steel System

TITANIUM SILENCER:

SGCM12300010T

HOLDER FOR SILENCER:

SGATT520

HOLDER TO THE FRAME:

SGATT518

CONNECTING TUBE:

SGYA8834*01

Y PIPE:

SGYA8834*02

dB KILLER INCLUDED:

G9944

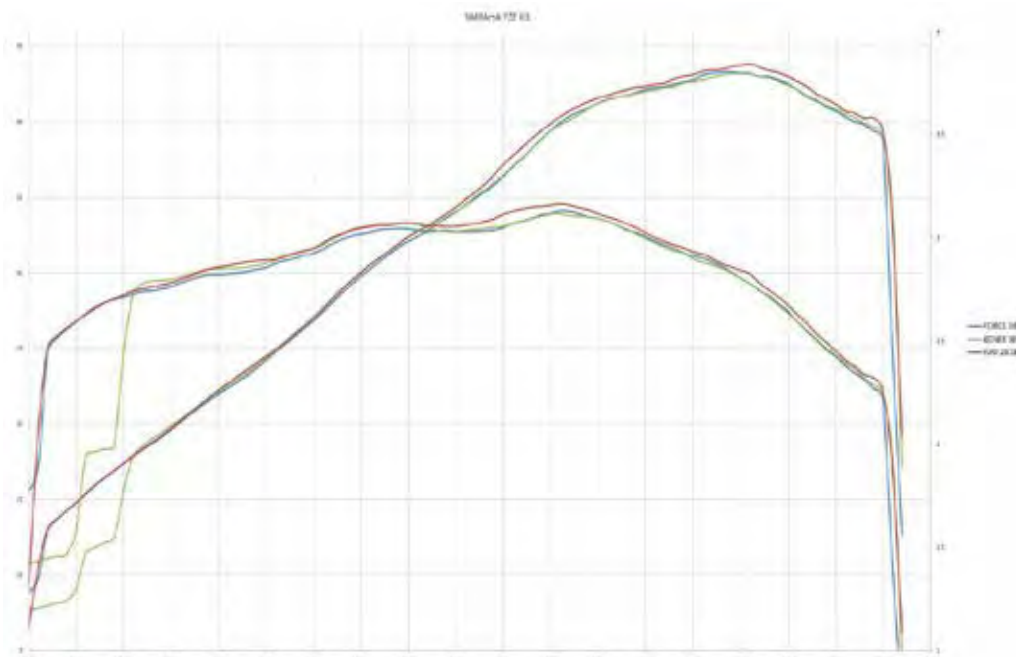
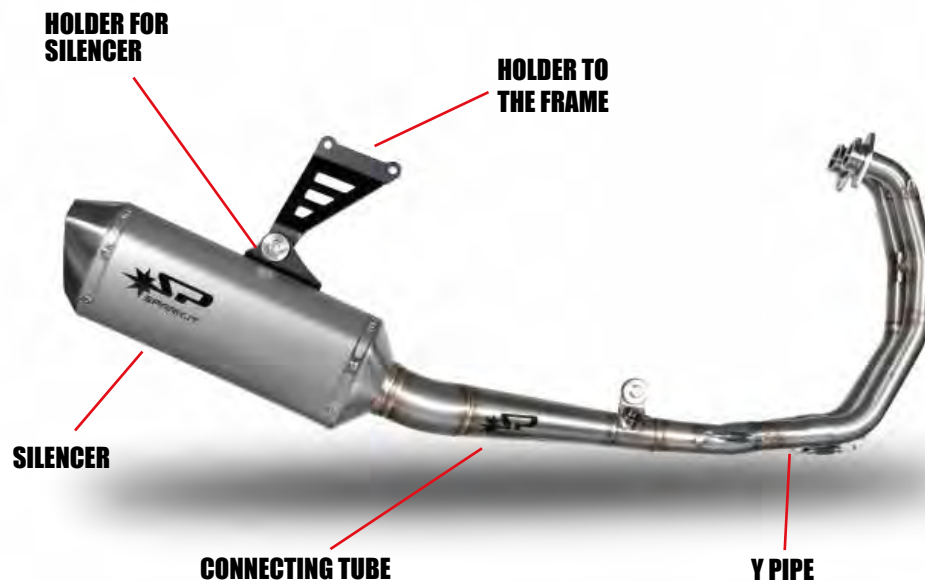

2017/2018

YAMAHA YZ-F R3

GYA8833T

FULL TITANIUM SYSTEM
TITANIUM collector + KONIX silencer

GYA8856T

FULL SYSTEM
STAINLESS STEEL collector + KONIX silencer

3,5 kg (-4,7)
WEIGHT

SPARE PARTS CODES:

	FOR GYA8833T Titanium System	FOR GYA8856T S.Steel System
TITANIUM SILENCER:	SGCM17300003T	SGCM17300003T
HOLDER FOR SILENCER:	SGATT521	SGATT521
HOLDER TO THE FRAME:	SGATT518	SGATT518
CONNECTING TUBE:	SGYA8833*01	SGYA8856*01
Y PIPE:	SGYA8833*02	SGYA8834*02

dB KILLER INCLUDED:

G9944

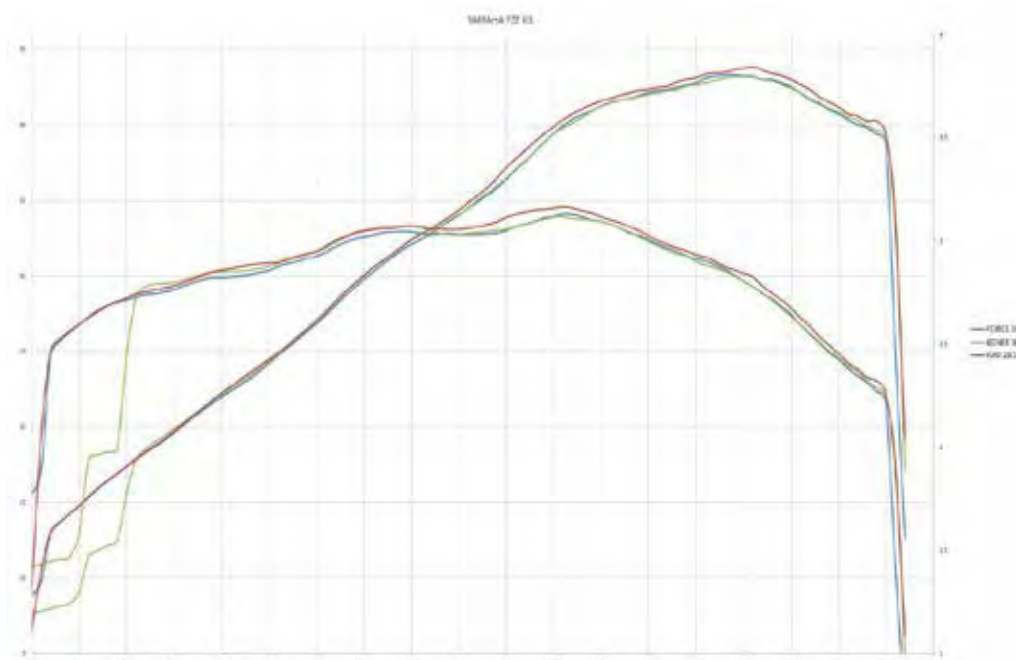
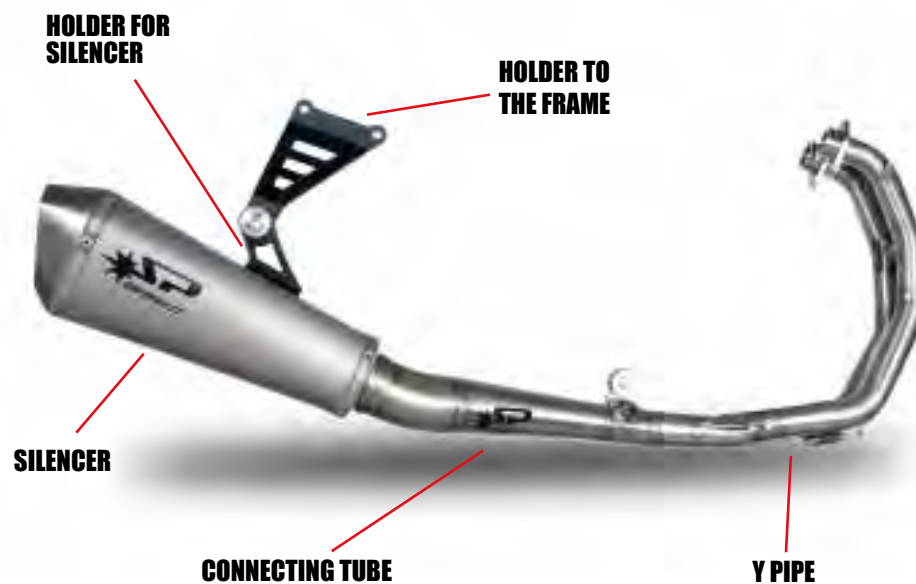

2017/2018

YAMAHA YZ-F R3

GYA8855T

FULL SYSTEM

STAINLESS STEEL collector + MOTO GP silencer

3 kg (-5,2)

WEIGHT

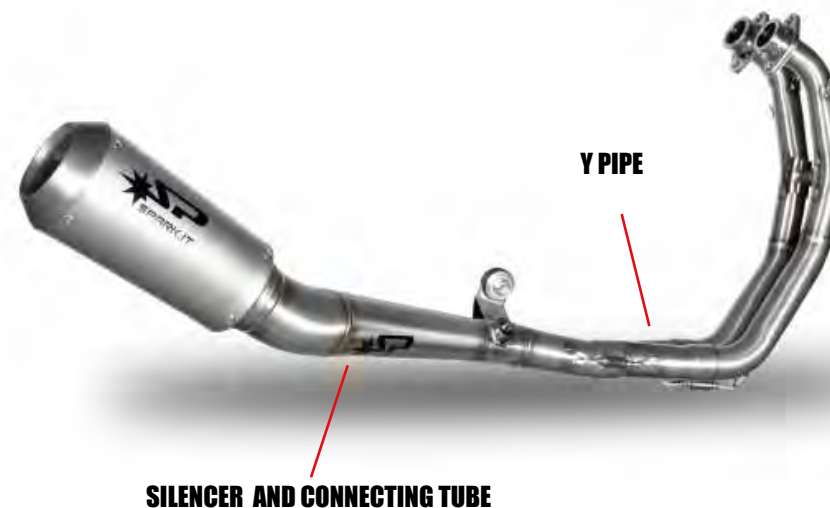

SPARE PARTS CODES:

FOR **GYA8855T**
S.Steel System

TITANIUM SILENCER AND
CONNECTING TUBE:

SGCM09175007T

Y PIPE:

GYA8834*02

OPTIONAL dB KILLER:

G9969





3rd Place in SSP300

 **CAMPIONATO
ITALIANO VELOCITÀ**



1st Place in SSP300

2007/2016

YAMAHA YZ-F R6

GYA8805T

FULL SYSTEM
STAINLESS STEEL collector + KONIX silencer

GYA8808T

FULL TITANIUM SYSTEM
TITANIUM collector + KONIX silencer



SPARE PARTS CODES:

	FOR GYA8808T Titanium System	FOR GYA8805T S.Steel System
TITANIUM SILENCER:	SGCM17300001T	SGCM17300001T
HOLDER FOR SILENCER:	SGATT336	SGATT336
HOLDER TO THE FRAME:	SGATT175	SGATT175
CONNECTING TUBE:	SGYA8808*01	SGYA8805*01
Y PIPE:	SGYA8808*02	SGYA8805*02

OPTIONAL dB KILLER:

G9954



2007/2016

YAMAHA YZ-F R6

GYA8853T

FULL SYSTEM
STAINLESS STEEL collector + FORCE silencer (102dB)

GYA8854T

FULL TITANIUM SYSTEM
TITANIUM collector + FORCE silencer (102dB)



SPARE PARTS CODES:

	FOR GYA8854T Titanium System	FOR GYA8853T S.Steel System
TITANIUM SILENCER:	SGCM12350001T	SGCM12350001T
TITANIUM SILENCER L.400	SGCM12400001T	SGCM12400001T
HOLDER FOR SILENCER:	SGATT563	SGATT563
HOLDER TO THE FRAME:	SGATT175	SGATT175
CONNECTING TUBE:	SGYA8808*01	SGYA8805*01
Y PIPE:	SGYA8808*02	SGYA8805*02

OPTIONAL dB KILLER: G9954



2007/2016

YAMAHA YZ-F R6

GYA8824T

FULL SYSTEM
STAINLESS STEEL collector + MOTO GP silencer

GYA8825T

FULL TITANIUM SYSTEM
TITANIUM collector + MOTO GP silencer



SPARE PARTS CODES:

	FOR GYA8825T Titanium System	FOR GYA8824T S.Steel System
TITANIUM SILENCER:	SGCM09175008T	SGCM09175008T
CONNECTING TUBE:	SGYA8808*01	SGYA8805*01
Y PIPE:	SGYA8808*02	SGYA8805*02

OPTIONAL dB KILLER:

G9969



2017/2019

YAMAHA YZ-F R6

GYA8838T

FULL SYSTEM
STAINLESS STEEL collector + FORCE silencer

GYA8839T

FULL TITANIUM SYSTEM
TITANIUM collector + FORCE silencer

103 dB LEVEL



SPARE PARTS CODES:

FOR **GYA8839T**
Titanium System

FOR **GYA8838T**
S.Steel System

TITANIUM SILENCER:	SGCM12350001T	SGCM12350001T
TITANIUM SILENCER L.400 (102dB)	SGCM12400001T	SGCM12400001T
HOLDER FOR SILENCER:	SGATT572	SGATT572
HOLDER TO THE FRAME:	SGATT571	SGATT571
CONNECTING TUBE:	SGYA8839*01	SGYA8838*01
Y PIPE:	SGYA8808*02	SGYA8805*02

OPTIONAL dB KILLER: G9954



2017/2019

YAMAHA YZ-F R6

GYA8840T

FULL SYSTEM
STAINLESS STEEL collector + KONIX silencer

GYA8841T

FULL TITANIUM SYSTEM
TITANIUM collector + KONIX silencer



SPARE PARTS CODES:

FOR **GYA8841T**
Titanium System

FOR **GYA8840T**
S.Steel System

TITANIUM SILENCER:	SGCM17300008T	SGCM17300008T
HOLDER FOR SILENCER:	SGATT573	SGATT573
HOLDER TO THE FRAME:	SGATT571	SGATT571
CONNECTING TUBE:	SGYA8839*01	SGYA8838*01
Y PIPE:	SGYA8808*02	SGYA8805*02

OPTIONAL dB KILLER: G9954



2017/2019

YAMAHA YZ-F R6

GYA8851T

FULL SYSTEM

STAINLESS STEEL collector + MOTO GP silencer

GYA8852T

FULL TITANIUM SYSTEM

TITANIUM collector + MOTO GP silencer



SPARE PARTS CODES:

FOR **GYA8852T**
Titanium System

FOR **GYA8851T**
S.Steel System

TITANIUM SILENCER:

SGCM09175008T

SGCM09175008T

CONNECTING TUBE:

SGYA8839*01

SGYA8838*01

Y PIPE:

SGYA8808*02

SGYA8805*02

OPTIONAL dB KILLER:

G9969



2017/2019

YAMAHA YZ-F R6 EVO 2019

GYA8863T

FULL SYSTEM
STAINLESS STEEL collector + FORCE silencer

GYA8864T

FULL TITANIUM SYSTEM
TITANIUM collector + FORCE silencer

102 dB LEVEL

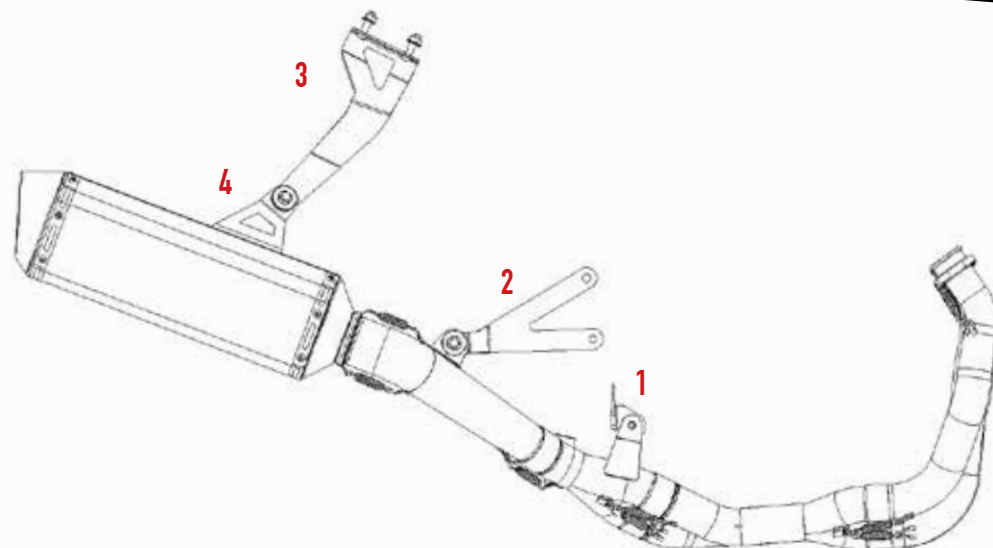

SPARE PARTS CODES:

FOR **GYA8864T**
Titanium System

FOR **GYA8863T**
S.Steel System

TITANIUM SILENCER L.350mm:	SGCM12350001T	SGCM12350001T
CONNECTING TUBE:	SGYA8864*01	SGYA8863*01
Y PIPE:	SGYA8864*02	SGYA8863*02
HOLDER TO THE FRAME 1 :	SGATT674	SGATT674
HOLDER TO THE FRAME 2 :	SGATT677	SGATT677
HOLDER TO THE FRAME 3 :	SGATT571	SGATT571
HOLDER FOR SILENCER 4 :	SGATT689	SGATT689

TITANIUM SILENCER L.300mm: SGCM12300015T

OPTIONAL dB KILLER: G9954



2017/2019

YAMAHA YZ-F R6 EVO 2019

GYA8865T

FULL TITANIUM SYSTEM

TITANIUM collector + KONIX silencer

GYA8863

S.STEEL RACING
COLLECTOR

+

GYA8865ST

TITANIUM KONIX
SILENCER

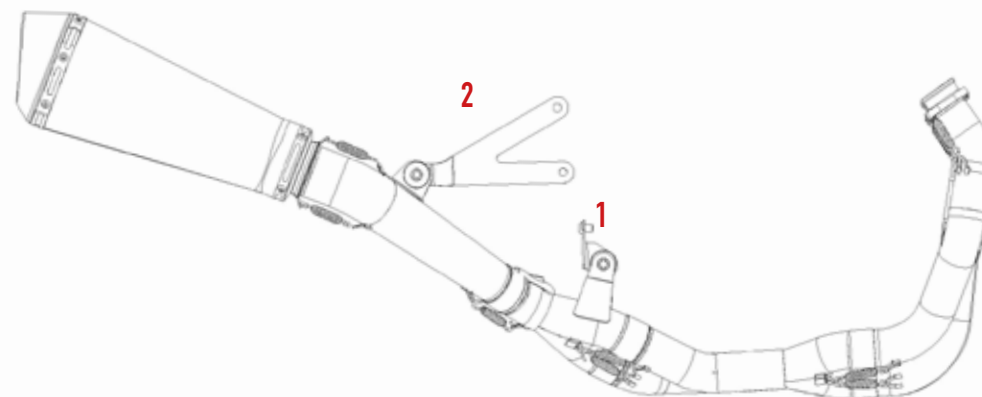

SPARE PARTS CODES:

FOR **GYA8865T**
Titanium System

FOR **GYA8863T**
S.Steel System

TITANIUM SILENCER L.350mm:

SGCM17300022T

SGCM17300022T

CONNECTING TUBE:

SGYA8864*01

SGYA8863*01

Y PIPE:

SGYA8864*02

SGYA8863*02

HOLDER TO THE FRAME **1**:

SGATT674

SGATT674

HOLDER TO THE FRAME **2**:

SGATT677

SGATT677

OPTIONAL dB KILLER:

G9954



2017/2019

YAMAHA YZ-F R6 EVO 2019

GYA8867T

FULL TITANIUM SYSTEM
TITANIUM collector + GRID-0 silencer

GYA8863
S.STEEL RACING
COLLECTOR

+

GYA8867ST
TITANIUM GRID-0
SILENCER

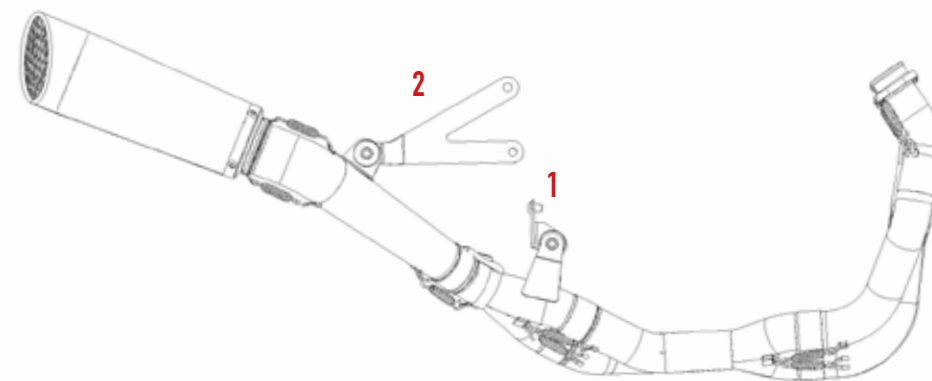

SPARE PARTS CODES:

FOR **GYA8867T**
Titanium System

FOR **GYA8863T**
S.Steel System

TITANIUM SILENCER L.350mm:	SGCM30215006T	SGCM30215006T
CONNECTING TUBE:	SGYA8864*01	SGYA8863*01
Y PIPE:	SGYA8864*02	SGYA8863*02
HOLDER TO THE FRAME 1 :	SGATT674	SGATT674
HOLDER TO THE FRAME 2 :	SGATT677	SGATT677

OPTIONAL dB KILLER: G9954





2015-2019

YAMAHA YZ-F R1

GYA8828T

3/4 KIT
STAINLESS STEEL collector + FORCE silencer (l.350mm)

4 kg (-4,1)

WEIGHT

GYA8829T

3/4 KIT
TITANIUM collector + FORCE silencer (l.350mm)

3 kg (-5,1)

WEIGHT



SPARE PARTS CODES:

FOR **GYA8829T**
Titanium System

FOR **GYA8828T**
S.Steel System

TITANIUM SILENCER:	SGCM12350011T	SGCM12350011T
HOLDER FOR SILENCER:	SGATT301	SGATT301
HOLDER TO THE FRAME:	SGATT523	SGATT523
HOLDER TO THE FOOTPEG:	SGATT371	SGATT371
CONNECTING TUBE:	SGYA8827*01	SGYA8826*01
Y PIPE:	SGYA8827*02	SGYA8826*02

OPTIONAL dB KILLER: G9954



2015-2019

YAMAHA YZ-F R1

GYA8830T

3/4 KIT
TITANIUM collector + MOTO GP silencer

1,7 kg (-6,4)
WEIGHT



SPARE PARTS CODES:

FOR **GYA8830T**
Titanium System

TITANIUM SILENCER: SGCM09175009T

HOLDER FOR SILENCER: SGATT394

HOLDER TO THE FOOTPEG: SGATT371

CONNECTING TUBE: SGYA8827*01

Y PIPE: SGYA8827*02

OPTIONAL dB KILLER: G9969



2015-2019

YAMAHA YZ-F R1

GYA8831T

FULL SYSTEM
S.STEEL collector + FORCE silencer (102dB)

GYA8832T

FULL TITANIUM SYSTEM
TITANIUM collector + FORCE silencer (102dB)

5,8 kg (-4,2)
WEIGHT

WORLD ENDURANCE VERSION

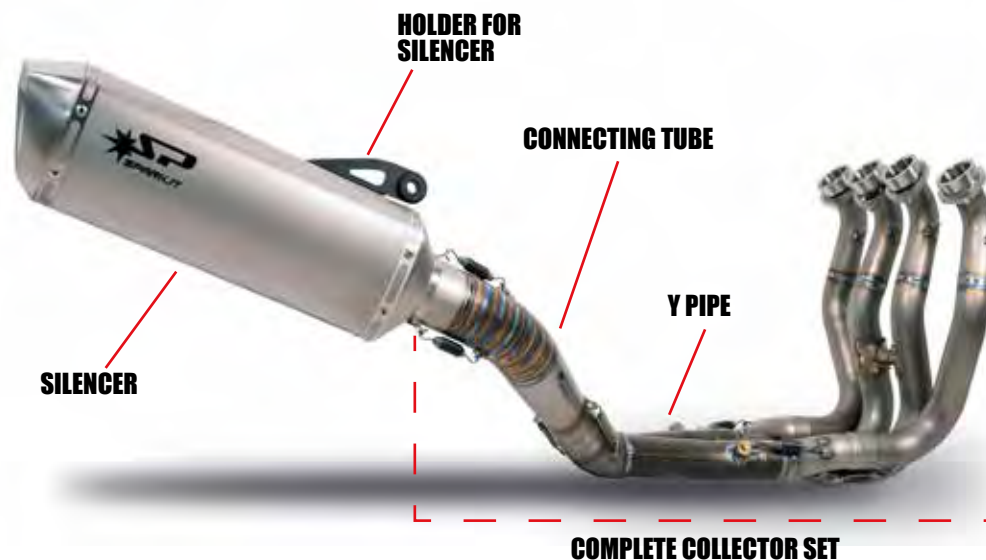

SPARE PARTS CODES:

	FOR GYA8832T Titanium System	FOR GYA8831T S.Steel System
TITANIUM SILENCER:	SGCM12350014T	SGCM12350014T
TITANIUM SILENCER L.400	SGCM12400015T	SGCM12400015T
HOLDER FOR SILENCER:	SGATT301	SGATT301
HOLDER TO THE FOOTPEG:	SGATT526	SGATT526
CONNECTING TUBE:	SGYA8832*01	SGYA8831*01
Y PIPE:	SGYA8832*02	SGYA8831*02
VALVE ELIMINATOR KIT:	SKIT040	SKIT040

COMPLETE COLLECTOR SET:

GYA8832

GYA8831

OPTIONAL dB KILLER:

G9954

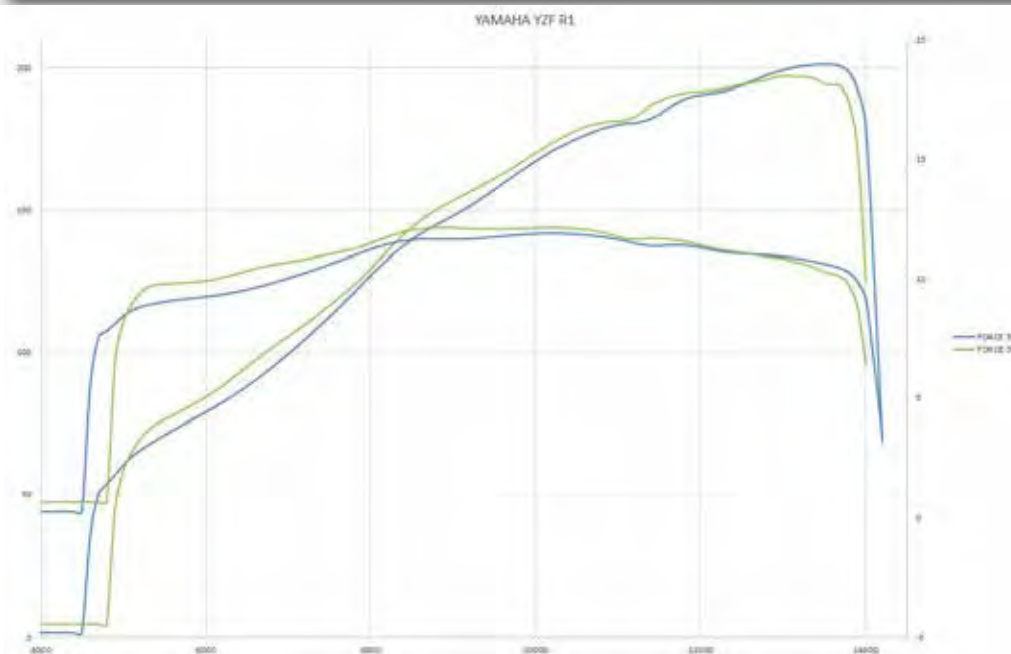

2015-2019

YAMAHA YZ-F R1

GYA8847T

FULL TITANIUM SYSTEM
TITANIUM collector + KONIX silencer (107dB)

5,3 kg (-4,7)
WEIGHT

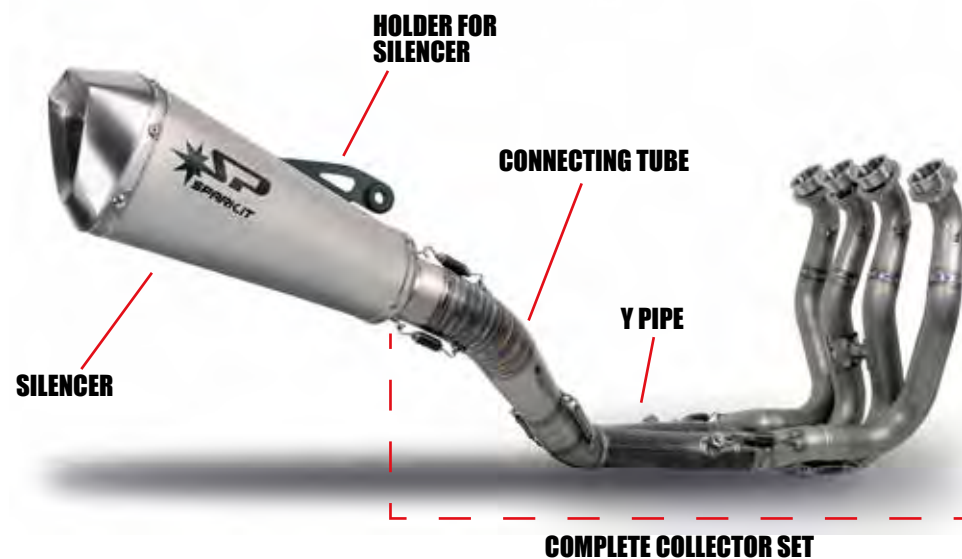

SPARE PARTS CODES:

FOR **GYA8847T**
Titanium System

TITANIUM SILENCER: SGCM17300005T

HOLDER FOR SILENCER: SGATT516

CONNECTING TUBE: SGYA8832*01

Y PIPE: SGYA8832*02

VALVE ELIMINATOR KIT: SKIT040

COMPLETE COLLECTOR SET: **GYA8832**

OPTIONAL dB KILLER: G9954

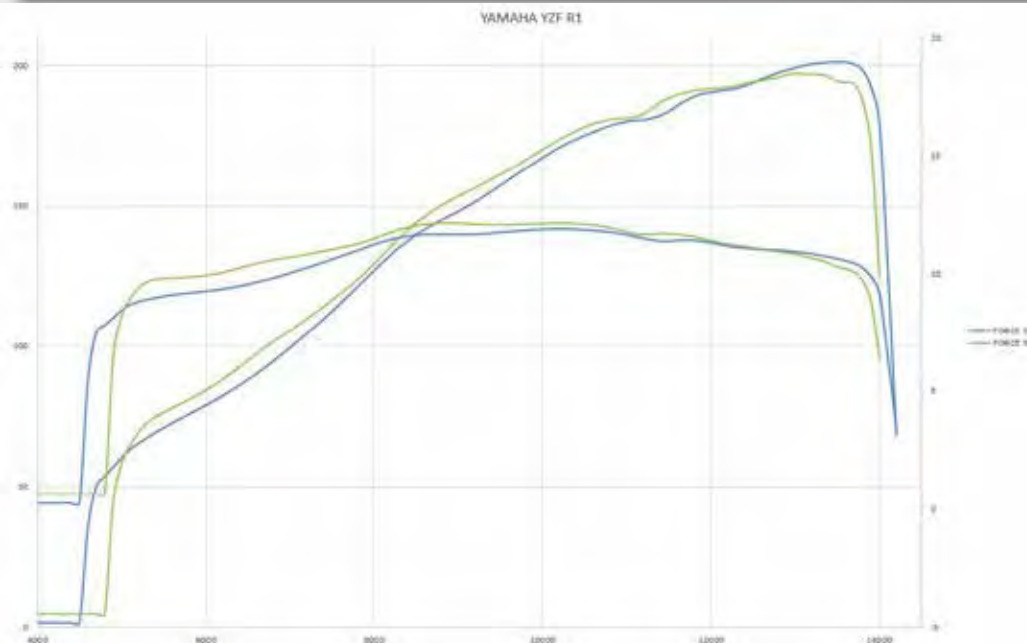

2015-2019

YAMAHA YZ-F R1

GYA8850T

FULL TITANIUM SYSTEM
TITANIUM collector + MOTO GP silencer

4,5 kg (-5,5)
WEIGHT

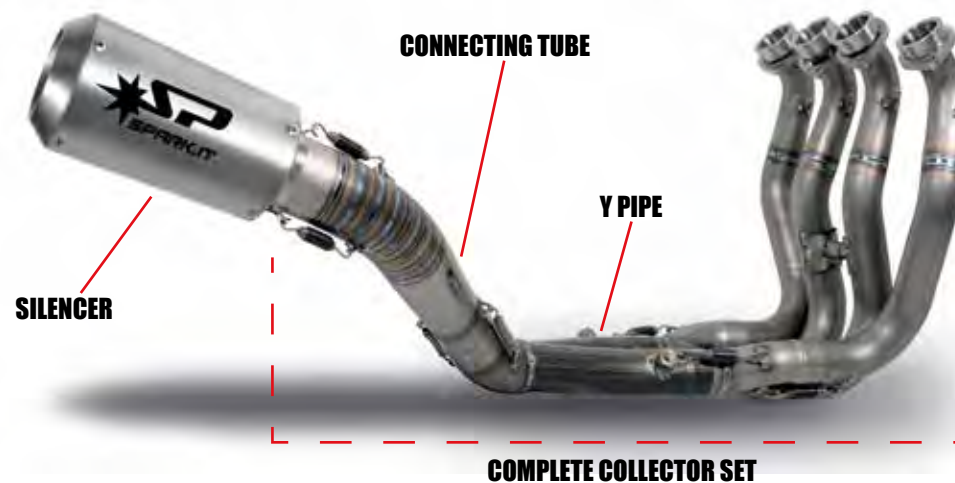

SPARE PARTS CODES:

FOR **GYA8850T**
Titanium System

TITANIUM SILENCER:

SGCM09175027T

CONNECTING TUBE:

SGYA8832*01

Y PIPE:

SGYA8832*02

VALVE ELIMINATOR KIT:

SKIT040

OPTIONAL dB KILLER:

G9969



2015-2019

YAMAHA YZ-F R1

GYA88...

FULL SYSTEM

S.STEEL collector + FORCE silencer (102dB)

GYA88...

FULL TITANIUM SYSTEM

TITANIUM collector + FORCE silencer (102dB)

WORLD ENDURANCE VERSION 2019



SPARE PARTS CODES:

FOR **GYA88**
Titanium System

FOR **GYA88**
S.Steel System

TITANIUM SILENCER:

TITANIUM SILENCER L.400

HOLDER FOR SILENCER:

HOLDER TO THE FOOTPEG:

CONNECTING TUBE:

Y PIPE:

VALVE ELIMINATOR KIT:

OPTIONAL dB KILLER:

69954



